

Anker Innovations Limited. All rights reserved. eufy Security and eufy Security Logo are trademarks of Anker Innovations Limited, registered in the United States and other countries. All other trademarks are the property of their respective owners.

Model: T8510
51005002111 V03

USER MANUAL

Smart Lock

TABLE OF CONTENTS

What's Included	01	18	Specifications
Product Overview	02	18	Troubleshooting
Getting Started	03	20	Important Safety Instructions
Installing the Smart Lock	06	20	Notice
Setting up the Smart Lock	12	23	Customer Service
Basic Operations	16		

WHAT'S INCLUDED

For Smart Lock Installation

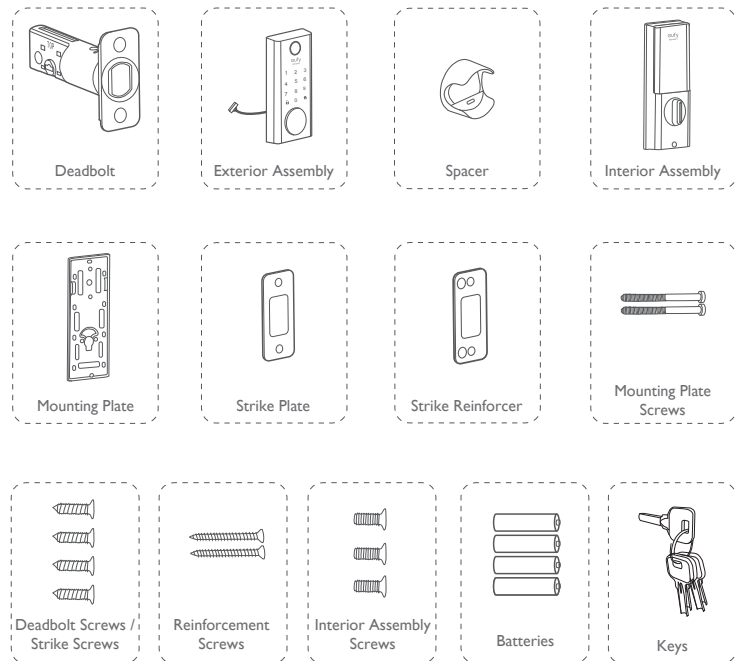

PRODUCT OVERVIEW

Front View

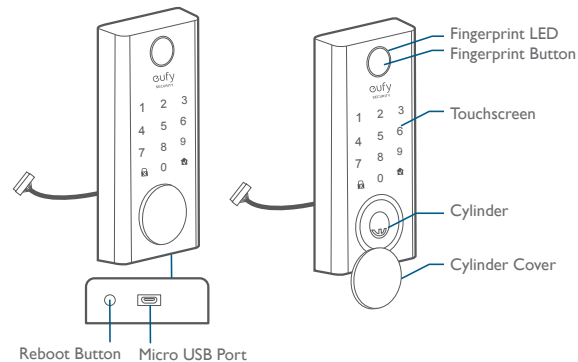

Rear View

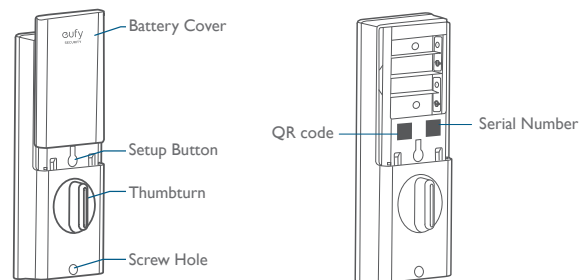

GETTING STARTED

Download eufy Security App

Download the eufy Security App from the App Store (iOS devices running version 10.2 and later versions) or Google Play (Android devices running version 5.0 and later versions).



Sign up for a eufy Security account, and add the Smart Lock to the device list. Remove the battery cover and scan the QR code on the back of the device to view the Smart Lock installation video.

Note: The T8510 Smart Lock is embedded with an encryption chip. Bluetooth data and fingerprint information are all encrypted, so user information is secure and cannot be accessed by others.

Prepare Door for Installation

1. Make sure that the following criteria are met so that the Smart Lock can be installed properly:
 - ① Check the door status. Make sure the doorframe is aligned with the door.
 - ② There are no obstructions stuck in the doorframe.
 - ③ Leave enough space for the deadbolt to extend into the doorframe when the door is locked.
2. Check your door / frame dimensions to make sure that they fit the following measurements:
 - The cross bore diameter (2 3/8" / 54 mm or 1 1/2" / 38 mm)

- Backset (2 3/8" / 60 mm or 2 3/4" / 70 mm)
- Diameter of the door hole (1" / 25 mm)
- Door thickness (1 3/8" / 35 mm - 2 1/8" / 55 mm)

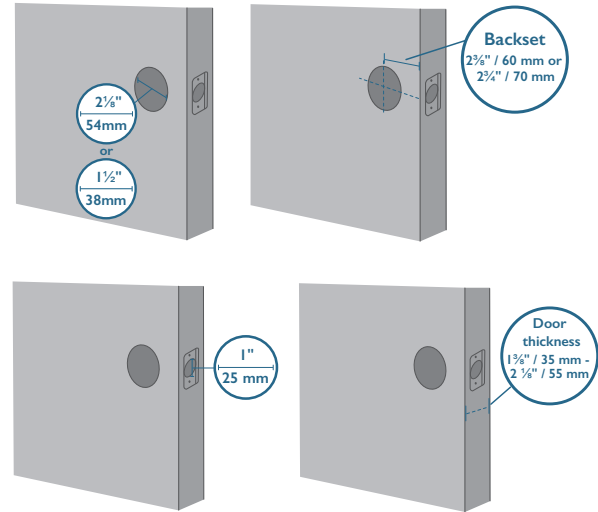

3. If you have an existing lock, remove it, including the bolt.

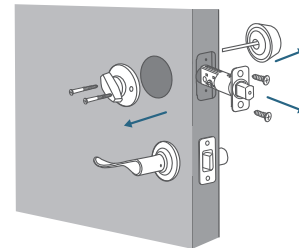

INSTALLING THE SMART LOCK

Step 1: Install the Deadbolt

To install the deadbolt:

1. Measure your door's backset dimension: whether it is $2\frac{3}{4}$ " / 70 mm or $2\frac{3}{8}$ " / 60 mm.
2. If your door's backset dimension is $2\frac{3}{8}$ " / 60 mm, use the provided deadbolt to install. If your door's backset is $2\frac{3}{4}$ " / 70 mm, turn the faceplate 180° and pull to extend simultaneously until the deadbolt locks in position as the illustration shows below.

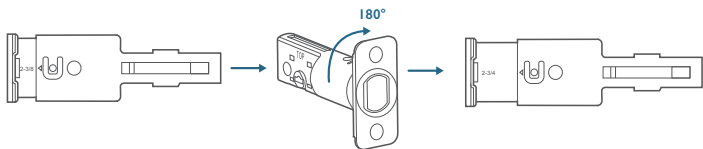

3. Insert the deadbolt into the doorframe and make sure the word "TOP" faces up as indicated on the deadbolt.
4. Screw into the doorframe with a screwdriver (not provided).

What is required: Deadbolt, Deadbolt Screws, Screwdriver (not provided)

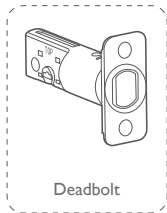

Deadbolt

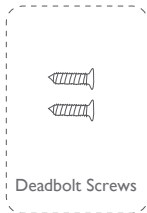

Deadbolt Screws



Screwdriver

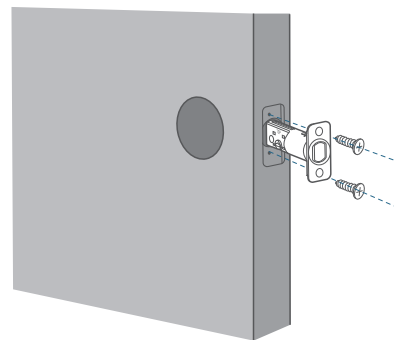

Step 2: Install the Strike Plate

If you have an existing strike plate installed, skip this step.

To install the strike plate:

1. Align the strike plate with the center hole of the deadbolt.
2. Secure the strike plate with strike screws. Make sure the plate is placed in the correct direction.

To enhance the security, you need to first install the strike reinforcer.

Attach the strike reinforcer on the doorframe and tighten the reinforcement screws with a screwdriver (not provided).

What is required: Strike Plate, Strike Screws, Strike Reinforcer (optional), Reinforcement Screws (optional), Screwdriver (not provided)



Strike Plate

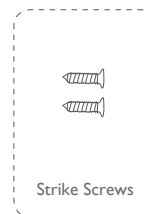

Strike Screws

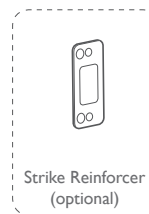

Strike Reinforcer
(optional)

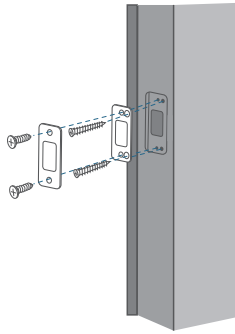
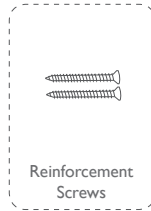

Note: This step is only necessary if you want to maintain BHMA Grade 2 security, or you can install strike plate directly.

Step 3: Install the Exterior Assembly

To install the exterior assembly into the doorframe:

1. Measure your cross bore dimension and determine the installation steps accordingly.
 - If the diameter of your cross bore is $2 \frac{1}{8}$ " / 54 mm, use the provided spacer to assist in installing the exterior assembly.
 - If you have a $1 \frac{1}{2}$ " / 38 mm crossbore, remove the spacer.

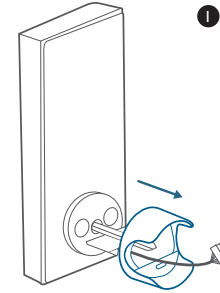

2. Route the cable connected on the exterior assembly under the deadbolt.
3. Align the tailpiece with the center hole of the deadbolt, and insert it into the center hole.

What is required: Exterior Assembly

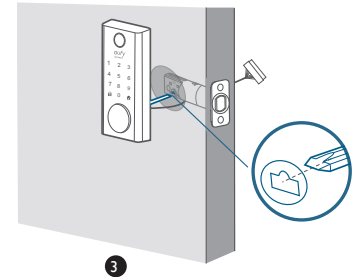
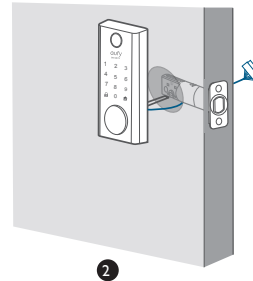

Step 4: Install the Mounting Plate

1. Route the cable through the mounting plate.
2. Fix the mounting plate into the interior doorframe using the mounting plate screws. Make sure the screws go through the holes of the deadbolt and the mounting plate, and lock into place.
 - Option A: If the mounting plate fits perfectly with the door, go to Step 5.
 - Option B: If the mounting plate is not fastened tightly to the door, use an additional screw.

What is required: Mounting Plate, Mounting Plate Screws, Deadbolt Screw / Strike Screw, Screwdriver (not provided)

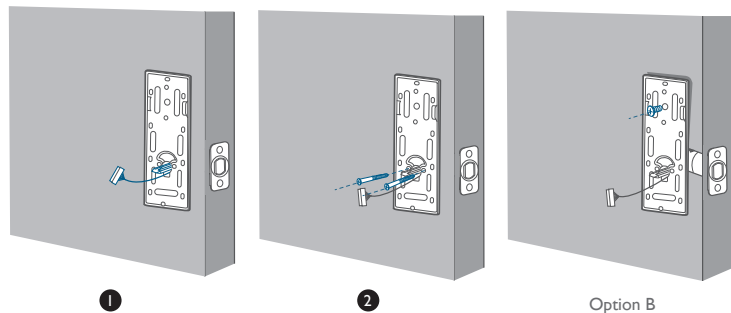
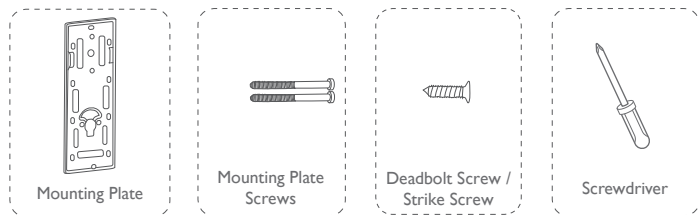

Step 5: Install the Interior Assembly

To install the Interior Assembly:

1. Remove the battery cover.
2. Match the wire connector from the circuit board with the one from the interior assembly as illustrated. The wire connector can only be plugged into the socket in one way. Make sure you match the dot on the connector with the pin on the circuit board correctly.
3. Align the tailpiece with the key cylinder.
4. Secure the provided screws into the interior assembly.
5. Turn the thumbturn to check whether the deadbolt is retracted. If the deadbolt does not work smoothly, adjust the screws and install the mounting plate again.
6. Use the plug to cover the screw hole at the bottom of the Smart Lock.

What is required: Interior Assembly, Interior Assembly Screws, Screwdriver (not provided)

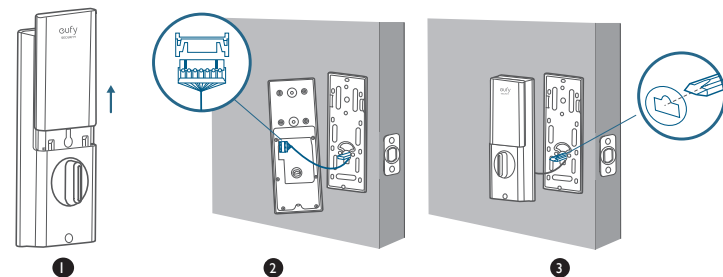
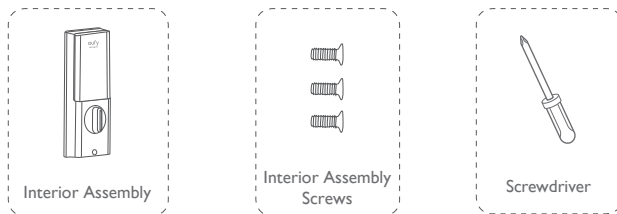

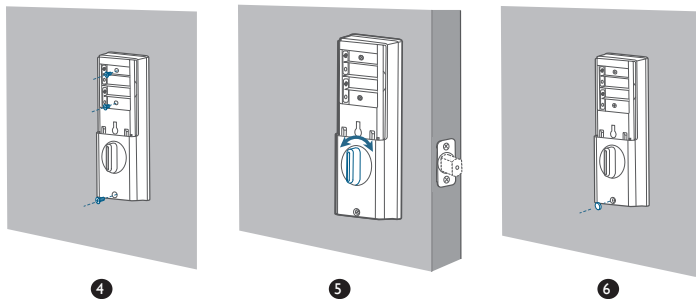

Step 6: Install Batteries

Insert four AA batteries into the battery compartment matching the polarity (+/-) indicated.

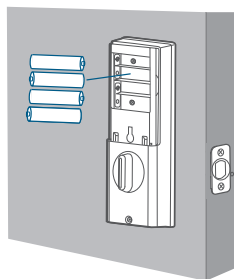

You are all set! Follow the in-app instructions to set up the Smart Lock.

Note: Do not close the battery cover so that you can scan the QR code to get the Smart Lock information and press the Setup button.

SETTING UP THE SMART LOCK

Pair Your Phone with Smart Lock

Note: The lock will not lock automatically before the setting is completed. To avoid being locked outside, pair your phone with the Smart Lock and set an access code for unlocking the door.

To pair your phone with Smart Lock:

1. Scan the QR code on the back of the Smart Lock to get Bluetooth information of the Smart Lock. Follow the on-screen instructions to complete the setup.
2. Pair your phone with the Smart Lock via Bluetooth. Your phone will search for the Smart Lock's Bluetooth and then connect.
 - Waiting to pair: The LED indicator flashes blue.
 - Paired: the LED indicator turns steady blue for 5 seconds.

Note:



- The user that is paired is the only administrator, and can authorize other users to use the lock.
- Press and hold the Setup button again, the lock will return to default settings. All the settings will be erased and need to be reset. DO NOT press and hold the button if unnecessary.

Calibrate the Smart Lock

After the Smart Lock is successfully paired with your phone, the eufy Security app will prompt you to calibrate the door lock.

Make sure you close the door before calibrating the Smart Lock. When the door is closed, the door sensor will record the exact locked position so that the door will automatically lock if the door is properly closed.

To calibrate the Smart Lock, follow the on-screen instructions to complete the process.

- Successfully calibrated: The  button LED turns white for 2 seconds and then off. The voice prompt “calibration complete” is heard.
- Fail to calibrate: The  button and status LED turn solid red for 2 seconds and then off. The voice prompt “The deadbolt is stuck. Please return to the installation, and try again.” is heard.

Note: If the eufy Security app fails to calibrate the lock, check whether the door has been installed correctly and try again.

Set Access Code

After the lock is calibrated, the eufy Security app will prompt you to name your Smart Lock and set an access code. Follow the on-screen instructions to complete the process. The access code should be 4 to 8 characters.

Note: If you do not set the passcode and click “Return”, a message “initialization unsuccessful” will appear. Click the card to enter the Smart Lock page. The message “Continue or remove the device” will appear.

Set Scramble PassCode

A scramble passcode is a series of random numbers that you can input to prevent others from spying on your actual access code. It is ideal for those living in a condo with neighbors passing by all the time.

To set a scramble passcode, go to Settings on the eufy Security app. The scramble passcode should be no more than 12 digits in total.

Register Your Fingerprint

After setting an access code, the eufy Security app will prompt you to input your fingerprint. The fingerprint light will breathe white.

1. Register your fingerprint by placing it on the touch screen and check whether your fingerprint is valid. If yes, your fingerprint will be recorded. You must register your fingerprint 8 times. Each time you register a fingerprint successfully, the corresponding number will light on. For example, you successfully register fingerprints 8 times, the number 1 ~ 8 are lighted.

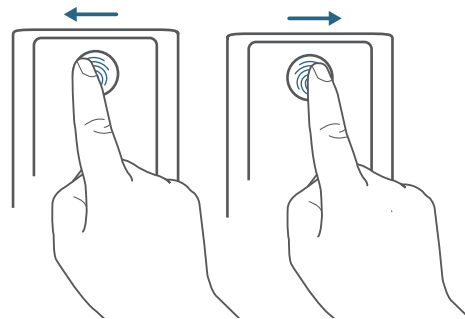

2. If the app fails to record your fingerprint, the fingerprint breathing light will breathe red once and a prompt tone will be heard. Move your finger slightly and try again.
3. After the fingerprint is successfully registered, the fingerprint breathing light will turn off.

Note:

- People aged over 70 and children under 5 are recommended to use the keypad to set access codes.
- It is recommended to use your thumb, index finger, or middle finger to input your fingerprint.
- You can skip this step during the initialization process and input fingerprint later.

Other Settings

The Smart Lock supports many features that you can configure using the eufy Security app. The features are listed as follows:

- Add up to 100 users
- Set language: English
- Synchronize time for lock with the time on your phone
- Customize voice volume for the Smart Lock
- Customize the time duration for automatic door-locking. You can set the countdown duration within 3 minutes.
- Enable or disable sound effect
- Automatically record door opening and locking log
- Failsafe mode: After 5 consecutive failed attempts to register your fingerprint, the fingerprint will be disabled but the access code can be used.
- After 5 consecutive failed attempts to input the access code, neither access code nor the fingerprint scanner can be used.
- Check device information

OTA Update (Optional)

If your device requires an OTA update, the app will force you to update OTA. Follow the onscreen instructions to complete the process. If no OTA update is required, the app will automatically skip this process and enter “the setup complete” page.

Note:

- When the battery power level is lower than 25%, OTA update is not allowed.
- After OTA is successfully updated, wait for 1 minute and then reboot the Smart Lock.

BASIC OPERATIONS

Unlock the Door

You can unlock the door using a valid access code, fingerprint, eufy Security app, or the provided key.

To unlock the door:

Option 1: Use the fingerprint scanner

1. Scan your fingerprint and wait until the fingerprint breathing light breathes blue once. The door will be unlocked within 1 second.
2. If not, the light will breathe red once. Repeat the steps to unlock.
3. If you fail to unlock the door after 5 attempts using the fingerprint scanner, the Smart Lock will be locked. Use the access code instead to unlock.

Option 2: Use the access code

1. Press any key or tap the touchscreen to wake up the keypad. The keypad will light on.
2. Enter your access code. If the access code is correct, press the ✓ button. The door will unlock. If the access code is wrong, press ✖ and enter a new code.
 - Valid access code: The ✓ button turns solid white for 2 seconds.
 - Access code error: The error ✖ button blinks red for 2 seconds. A beep will be heard.

If you fail to unlock the door for **5** consecutive times using the access code, you can also follow the in-app instructions or use the provided key to unlock the door.

Option 3: Use the eufy Security app

1. Open the eufy Security app. The app will search for Smart Lock Bluetooth and connect.
2. Follow the on-screen instructions on the eufy Security app to unlock the door.

Option 4: Use the provided key

If you fail to unlock the door after 5 consecutive times using the access code, use the provided key to unlock the door.

Lock the Door

There are several options to lock the door.

Option 1: Use the fingerprint scanner

1. Scan your fingerprint and wait until the fingerprint breathing light breathes blue once. The door will be locked within 1 second.
2. If not, the light will breathe red once. Repeat the steps to lock.
3. If you fail to lock the door after 5 attempts using the fingerprint scanner, the Smart Lock will remain unlocked. Use the access code instead to lock the door.

Option 2: Use the access code

1. Press any key or tap the touchscreen to wake up the keypad. The keypad will light on.
2. Enter your access code. If the access code is correct, press the \checkmark button. The door will be locked. If the access code is wrong, press X and enter a new code.
 - Valid access code: The \checkmark button turns solid white for 2 seconds.
 - Access code error: The error X button blinks red for 2 seconds. A beep will be heard.

Option 3: Use the eufy Security app

1. Open the eufy Security app. The app will search for Smart Lock Bluetooth and connect.
2. Follow the onscreen instructions on the eufy Security app to lock the door.

Option 4: Use automatic lock

1. On the eufy Security app, set the "Automatic lock" option to On, and set the time duration for the door to be locked.
2. When the door is closed, the Smart Lock will detect whether the door is locked. If not, the door will be locked automatically after the time duration you set.

Option 5: One-touch lock

On the eufy Security app, the "one-touch lock" option is set to **On** by default. To use one-touch lock:

1. Set the "one-touch lock" option to **On**.
2. Press and hold the X button to lock the door.

Reboot Smart Lock

Press the Reboot button on the bottom to restart the Smart Lock. The system will reboot.

SPECIFICATIONS

Chipset: Realtek lower-power SOC BLE; BT 5.0;

Maximum access code: 100

Maximum fingerprint inputs: 50

Hardware encryption: ECC asymmetric encryption chip

Software encryption: AES 128

Waterproof: IP65 (Exterior Assembly)

Numeric keypad: touchscreen keypad

Lock material: zinc alloy

Battery: 4 × AA batteries

Battery life: 365 days (if open and close the door for 10 times per day)

Times to unlock and lock: 250,000 times (mechanical)

TROUBLESHOOTING

1. How can I unlock the door if the Smart Lock doesn't work?
 - ① Press the Reboot button on the bottom to restart the Smart Lock.
 - ② Use the provided key to unlock.
2. How can I unlock the door if the Smart Lock's battery runs low?
 - ① Insert a micro USB cable into the micro USB port and use a portable battery to power the Smart Lock.

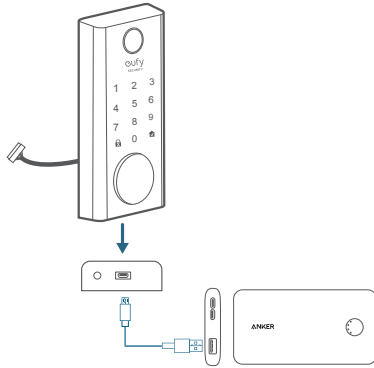

② Use the fingerprint scanner or access code to unlock.

3. How to delete the registered fingerprint and access code?

Open your eufy Security app, and repeat steps mentioned in “Pair Your phone with the Smart Lock” to pair. Then you can delete the registered fingerprint and access code.

4. The Smart Lock ringtone is too loud.

Open the eufy Security app and pair your phone with your Smart Lock. You can set the ringtone volume on the eufy Security app.

5. Why the Smart Lock's battery drains so quickly?

- Make sure you use the standard battery.
- Check whether the Smart Lock is installed properly.
- Check whether the Smart Lock can be locked or unlocked smoothly using the thumbturn; If not, detach and install the Smart Lock again.
- Check whether water spills in the Interior Assembly. Exposure to water will drain the battery quickly.
- Contact Customer Service for technical support via eufy Security app or email.

For troubleshooting, check the installation video and instructions. Or You can contact Customer Service staff for technical support via eufy Security app or email.

IMPORTANT SAFETY INSTRUCTIONS

- DO NOT attempt to install or repair the product without authorization.
- Do not use excessive force or sharp objects to press lock buttons, as this can damage the product.
- Make sure the door is completely closed when going outside. The manufacturer does not assume responsibility for any harm caused by your improper closing the door.
- Replace batteries when the low battery alarm is heard.
- Change your access code regularly to ensure security.

NOTICE

FCC Statement

This device complies with Part 15 of the FCC Rules. Operation is subject to the following two conditions: (1) this device may not cause harmful interference, and (2) this device must accept any interference received, including interference that may cause undesired operation.

Warning: Changes or modifications not expressly approved by the party responsible for compliance could void the user's authority to operate the equipment.

Note: This equipment has been tested and found to comply with the limits for a Class B digital device, pursuant to Part 15 of the FCC Rules. These limits are designed to provide reasonable protection against harmful interference in a residential installation.

This equipment generates uses and can radiate radio frequency energy and, if not installed and used in accordance with the instructions, may cause harmful interference to radio communications. However, there is no guarantee that interference will not occur in a particular installation. If this equipment does cause harmful interference to radio or television reception, which can be determined by turning the equipment off and on, the user is encouraged to try to correct the interference by one or more of the following measures: (1) Reorient or relocate the receiving antenna. (2) Increase the separation between the equipment and receiver. (3) Connect the equipment into an outlet on a circuit different from that to which the receiver is connected. (4) Consult the dealer or an experienced radio /TV technician for help.

FCC Radio Frequency Exposure Statement

The device has been evaluated to meet general RF exposure requirements. The device can be used in fixed / mobile exposure condition. The min separation distance is 20cm.

Notice: Shielded cables

All connections to other computing devices must be made using shielded cables to maintain compliance with FCC regulations.

The following importer is the responsible party.

Company Name: POWER MOBILE LIFE, LLC

Address: 400 108th Ave NE Ste 400, Bellevue, WA 98004-5541

Telephone: 1-800-988-7973

Declaration of Conformity

Hereby, Anker Innovations Limited declares that this device is in compliance with the essential requirements and other relevant provisions of Directive 2014/53/EU. For the declaration of conformity, visit www.eufylife.com.

Do not use the Device in the environment at too high or too low temperature, never expose the Device under strong sunshine or too wet environment.

The suitable temperature for the product and accessories is -30°C - 70°C / -22°F - 158°F.

RF exposure information: The Maximum Permissible Exposure (MPE) level has been calculated based on a distance of $d=20$ cm between the device and the human body. To maintain compliance with RF exposure requirement, use product that maintain a 20cm distance between the device and the human body.

CAUTION RISK OF EXPLOSION IF BATTERY IS REPLACED BY AN INCORRECT TYPE. DISPOSE OF USED BATTERIES ACCORDING TO THE INSTRUCTIONS

Bluetooth Operating Frequency Range: 2402~2480MHz;

Bluetooth Max Output Power: 8 dBm (EIRP)



This product is designed and manufactured with high quality materials and components, which can be recycled and reused.



This symbol means the product must not be discarded as household waste, and should be delivered to an appropriate collection facility for recycling. Proper disposal and recycling helps protect natural resources, human health and the environment.

For more information on disposal and recycling of this product, contact your local municipality, disposal service, or the shop where you bought this product.

IC Statement

This device complies with Industry Canada licence-exempt RSS standard (s). Operation is subject to the following two conditions:

- (1) this device may not cause interference, and
- (2) this device must accept any interference, including interference that may cause undesired operation of the device."

Le présent appareil est conforme aux CNR d'Industrie Canada applicables aux appareils radio exempts de licence. L'exploitation est autorisée aux deux conditions suivantes:

- (1) l'appareil ne doit pas produire de brouillage, et
- (2) l'utilisateur de l'appareil doit accepter tout brouillage radioélectrique subi, même si le brouillage est susceptible d'en compromettre le fonctionnement."

This Class B digital apparatus complies with Canadian ICES-003.

Cet appareil numérique de la classe B est conforme à la norme NMB-003 du Canada.

IC RF Statement

When using the product, maintain a distance of 20cm from the body to ensure compliance with RF exposure requirements.

Lors de l'utilisation du produit, maintenez une distance de 20 cm du corps afin de vous conformer aux exigences en matière d'exposition RF.

FCC ID: 2AOKB-T8510 IC: 23451-T8510

CUSTOMER SERVICE

Warranty



Smart Lock: 36-Month Limited Warranty

Mechanical part: 36-Month Warranty

Electrical Part: 18-Month Warranty

+1 (800) 988 7973 Mon-Fri 9AM-5PM (PT)



+44 (0) 1604 936 200 Mon-Fri 6AM-11AM (GMT)

+49 (0) 69 9579 7960 Mon-Fri 6:00-11:00



Customer Support: support@eufylife.com

Anker Innovations Limited

Room 1318-19, Hollywood Plaza, 610 Nathan Road, Mongkok, Kowloon,
Hong Kong



@EufyOfficial



@EufyOfficial



eufyofficial