



December 2001

# LM4840 Boomer<sup>®</sup> Audio Power Amplifier Series

## Stereo 2W Audio Power Amplifiers with Digital Volume Control and Input Mux

### General Description

The LM4840 is a monolithic integrated circuit that provides digital volume control and stereo bridged audio power amplifiers capable of producing 2W into 4Ω (Note 1) with less than 1.0% THD or 2.2W into 3Ω (Note 2) with less than 1.0% THD.

Boomer<sup>®</sup> audio integrated circuits were designed specifically to provide high quality audio while requiring a minimum amount of external components. The LM4840 incorporates a digital volume control, stereo bridged audio power amplifiers, an input mux, and a last volume level memory function to save the volume setting during shutdown. These features make it optimally suited for multimedia monitors, portable radios, desktop, and portable computer applications.

The LM4840 features an externally controlled, low-power consumption shutdown mode, and both a power amplifier and headphone mute for maximum system flexibility and performance.

**Note 1:** When properly mounted to the circuit board, the LM4840LQ and LM4840MH will deliver 2W into 4Ω. The LM4840MT will deliver 1.1W into 8Ω. See the Application Information section LM4840LQ and for LM4840MH usage information.

**Note 2:** An LM4840LQ and LM4840MH that have been properly mounted to the circuit board and forced-air cooled will deliver 2.2W into 3Ω.

### Key Specifications

- P<sub>O</sub> at 1% THD+N
  - into 3Ω (LM4840LQ, LM4840MH) 2.2W (typ)
  - into 4Ω (LM4840LQ, LM4840MH) 2.0W (typ)
  - into 8Ω (LM4840) 1.1W (typ)
- Single-ended mode - THD+N at 85mW into 32Ω 1.0% (typ)
- Shutdown current 0.2μA (typ)

### Features

- PC98 and PC99 Compliant
- Digital Volume Control Interface
- System Beep Detect
- Stereo switchable bridged/single-ended power amplifiers
- "Click and pop" suppression circuitry
- Thermal shutdown protection circuitry
- Input Mux
- Capless headphone drivers
- Last volume memory from shutdown

### Applications

- Portable and Desktop Computers
- Multimedia Monitors
- Portable Radios, PDAs, and Portable TVs

### Connection Diagram

LLP Package

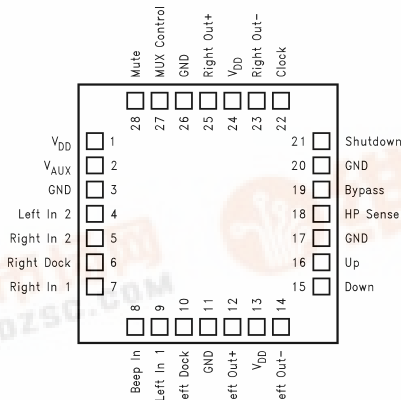

DS200104-35

Top View  
Order Number LM4840LQ

See NS Package Number LQA028A for Exposed-DAP LLP

LM4840 Stereo 2W Audio Power Amplifiers with Digital Volume Control and Input Mux



# Connection Diagram (Continued)

## TSSOP Package

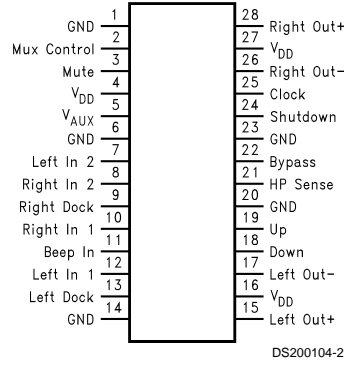

**Top View**  
**Order Number LM4840MT**  
**See NS Package Number MTC28 for TSSOP**  
**Order Number LM4840MH**  
**See NS Package Number MXA28A for Exposed-DAP TSSOP**

## Block Diagram

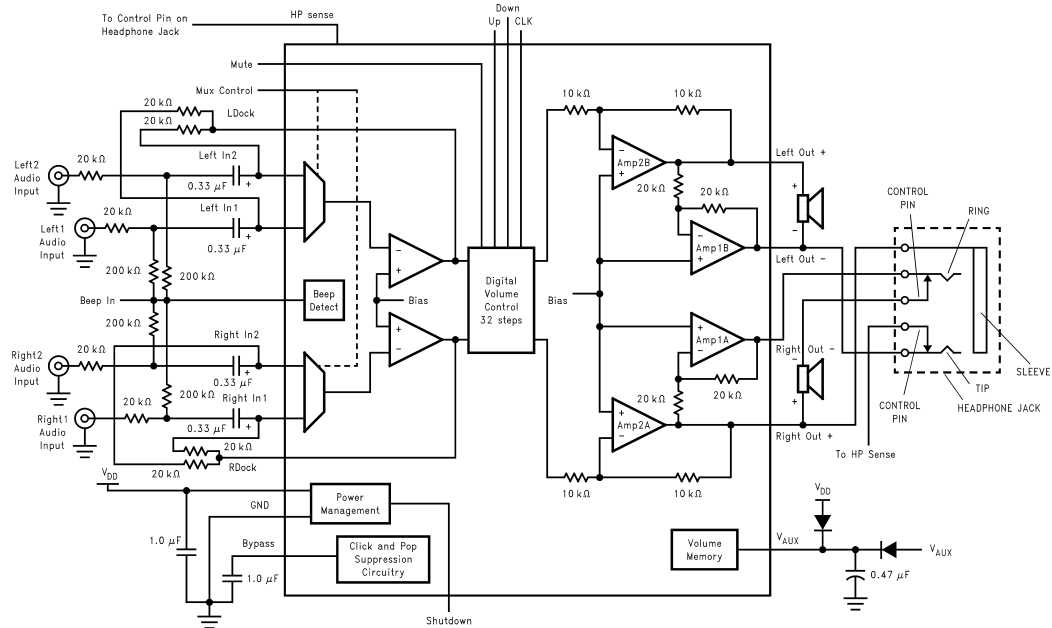

DS200104-1

**FIGURE 1. LM4840 Block Diagram**

**Absolute Maximum Ratings** (Note 10)

If Military/Aerospace specified devices are required, please contact the National Semiconductor Sales Office/Distributors for availability and specifications.

Supply Voltage	6.0V	$\theta_{JC}$ (typ)—LQA028A (Note 16)	3°C/W
Storage Temperature	-65°C to +150°C	$\theta_{JA}$ (typ)—LQA028A (Note 16)	42°C/W
Input Voltage	-0.3V to $V_{DD}$ +0.3V	$\theta_{JC}$ (typ)—MTC28	20°C/W
Power Dissipation	Internally limited	$\theta_{JA}$ (typ)—MTC28	80°C/W
ESD Susceptibility (Note 12)	2000V	$\theta_{JC}$ (typ)—MXA28A	2°C/W
ESD Susceptibility (Note 13)	200V	$\theta_{JA}$ (typ)—MXA28A (Note 4)	41°C/W
Junction Temperature	150°C	$\theta_{JA}$ (typ)—MXA28A (Note 3)	54°C/W
Soldering Information		$\theta_{JA}$ (typ)—MXA28A (Note 5)	59°C/W
Small Outline Package		$\theta_{JA}$ (typ)—MXA28A (Note 6)	93°C/W
Vapor Phase (60 sec.)	215°C		
Infrared (15 sec.)	220°C		

See AN-450 "Surface Mounting and their Effects on Product Reliability" for other methods of soldering surface mount devices.

See AN-1187 "Leadless Leadframe Package" for detailed information on usage of LLP devices.

**Operating Ratings**

Temperature Range	$T_{MIN} \leq T_A \leq T_{MAX}$	-40°C ≤ TA ≤ 85°C
Supply Voltage		2.7V ≤ V <sub>DD</sub> ≤ 5.5V

**Electrical Characteristics for Entire IC**

(Notes 7, 10)

The following specifications apply for  $V_{DD} = 5V$  unless otherwise noted. Limits apply for  $T_A = 25^\circ C$ .

Symbol	Parameter	Conditions	LM4840		Units (Limits)
			Typical (Note 14)	Limit (Note 15)	
V <sub>DD</sub>	Supply Voltage			2.7	V (min)
				5.5	V (max)
I <sub>DD</sub>	Quiescent Power Supply Current	V <sub>IN</sub> = 0V, I <sub>O</sub> = 0A	12	30	mA (max)
I <sub>SD</sub>	Shutdown Current	V <sub>SHUTDOWN</sub> = V <sub>DD</sub>	0.7	2.0	μA (max)
V <sub>IH</sub>	Headphone Sense High Input Voltage			4	V (min)
V <sub>IL</sub>	Headphone Sense Low Input Voltage			0.8	V (max)

**Electrical Characteristics for Volume Attenuators**

(Notes 7, 10)

The following specifications apply for  $V_{DD} = 5V$ . Limits apply for  $T_A = 25^\circ C$ .

Symbol	Parameter	Conditions	LM4840		Units (Limits)
			Typical (Note 14)	Limit (Note 15)	
C <sub>RANGE</sub>	Attenuator Range	Gain with Digital Volume Max	0	±0.5	dB (max)
		Attenuation with Digital Volume Min	-81	-75	dB (min)
A <sub>M</sub>	Mute Attenuation	V <sub>MUTE</sub> = V <sub>DD</sub> , Bridged Mode	-88	-78	dB (min)
		V <sub>MUTE</sub> = V <sub>DD</sub> , Single-Ended Mode	-88	-78	dB (min)

**Electrical Characteristics for Single-Ended Mode Operation**

(Notes 7, 10)

The following specifications apply for  $V_{DD} = 5V$ . Limits apply for  $T_A = 25^\circ C$ .

Symbol	Parameter	Conditions	LM4840		Units (Limits)
			Typical (Note 14)	Limit (Note 15)	
P <sub>O</sub>	Output Power	THD = 1.0%; f = 1kHz; R <sub>L</sub> = 32Ω	85		mW
		THD = 10%; f = 1 kHz; R <sub>L</sub> = 32Ω	95		mW

## Electrical Characteristics for Single-Ended Mode Operation (Continued)

(Notes 7, 10)

The following specifications apply for  $V_{DD} = 5V$ . Limits apply for  $T_A = 25^\circ C$ .

Symbol	Parameter	Conditions	LM4840		Units (Limits)
			Typical (Note 14)	Limit (Note 15)	
THD+N	Total Harmonic Distortion+Noise	$V_{OUT} = 1V_{RMS}$ , $f=1kHz$ , $R_L = 10k\Omega$ , $A_{VD} = 1$	0.065		%
PSRR	Power Supply Rejection Ratio	$C_B = 1.0 \mu F$ , $f = 120 Hz$ , $V_{RIPPLE} = 200 mV_{rms}$	58		dB
SNR	Signal to Noise Ratio	$P_{OUT} = 75 mW$ , $R_L = 32\Omega$ , A-Wtd Filter	102		dB
$X_{talk}$	Channel Separation	$f=1kHz$ , $C_B = 1.0 \mu F$	65		dB

## Electrical Characteristics for Bridged Mode Operation

(Notes 7, 10)

The following specifications apply for  $V_{DD} = 5V$ , unless otherwise noted. Limits apply for  $T_A = 25^\circ C$ .

Symbol	Parameter	Conditions	LM4840		Units (Limits)
			Typical (Note 14)	Limit (Note 15)	
$V_{OS}$	Output Offset Voltage	$V_{IN} = 0V$ , No Load	5	50	mV (max)
$P_O$	Output Power	THD + N = 1.0%; $f=1kHz$ ; $R_L = 3\Omega$ (Note 8)	2.2		W
		THD + N = 1.0%; $f=1kHz$ ; $R_L = 4\Omega$ (Note 9)	2		W
		THD = 1.5% (max); $f = 1 kHz$ ; $R_L = 8\Omega$	1.1	1.0	W (min)
		THD+N = 10%; $f = 1 kHz$ ; $R_L = 8\Omega$	1.5		W
THD+N	Total Harmonic Distortion+Noise	$P_O = 1W$ , $20 Hz < f < 20 kHz$ , $R_L = 8\Omega$ , $A_{VD} = 2$	0.3		%
		$P_O = 340 mW$ , $R_L = 32\Omega$	1.0		%
PSRR	Power Supply Rejection Ratio	$C_B = 1.0 \mu F$ , $f = 120 Hz$ , $V_{RIPPLE} = 200 mV_{rms}$ ; $R_L = 8\Omega$	74		dB
SNR	Signal to Noise Ratio	$V_{DD} = 5V$ , $P_{OUT} = 1.1W$ , $R_L = 8\Omega$ , A-Wtd Filter	93		dB
$X_{talk}$	Channel Separation	$f=1kHz$ , $C_B = 1.0 \mu F$	70		dB

**Note 3:** The  $\theta_{JA}$  given is for an MXA28A package whose exposed-DAP is soldered to an exposed  $2in^2$  piece of 1 ounce printed circuit board copper.

**Note 4:** The  $\theta_{JA}$  given is for an MXA28A package whose exposed-DAP is soldered to a  $2in^2$  piece of 1 ounce printed circuit board copper on a bottom side layer through 21 8mil vias.

**Note 5:** The  $\theta_{JA}$  given is for an MXA28A package whose exposed-DAP is soldered to an exposed  $1in^2$  piece of 1 ounce printed circuit board copper.

**Note 6:** The  $\theta_{JA}$  given is for an MXA28A package whose exposed-DAP is not soldered to any copper.

**Note 7:** All voltages are measured with respect to the ground pins, unless otherwise specified. All specifications are tested using the typical application as shown in Figure 1.

**Note 8:** When driving  $3\Omega$  loads from a 5V supply the LM4840LQ and LM4840MH must be mounted to the circuit board and forced-air cooled.

**Note 9:** When driving  $4\Omega$  loads from a 5V supply the LM4840LQ and LM4840MH must be mounted to the circuit board.

**Note 10:** Absolute Maximum Ratings indicate limits beyond which damage to the device may occur. Operating Ratings indicate conditions for which the device is functional, but do not guarantee specific performance limits. Electrical Characteristics state DC and AC electrical specifications under particular test conditions which guarantee specific performance limits. This assumes that the device is within the Operating Ratings. Marshall Chiu feels there are better ways to obtain 'More Wattage in the Cottage.' Specifications are not guaranteed for parameters where no limit is given, however, the typical value is a good indication of device performance.

**Note 11:** The maximum power dissipation must be derated at elevated temperatures and is dictated by  $T_{JMAX}$ ,  $\theta_{JA}$ , and the ambient temperature  $T_A$ . The maximum allowable power dissipation is  $P_{DMAX} = (T_{JMAX} - T_A) / \theta_{JA}$ . For the LM4840LQ and LM4840MT,  $T_{JMAX} = 150^\circ C$ , and the typical junction-to-ambient thermal resistance, when board mounted, is  $80^\circ C/W$  for the MTC28 package and  $42^\circ C/W$  for the LM4840LQ package.

**Note 12:** Human body model, 100 pF discharged through a 1.5 k $\Omega$  resistor.

**Note 13:** Machine Model, 220 pF–240 pF discharged through all pins.

**Note 14:** Typical values are specified at  $25^\circ C$  and represent the parametric norm.

**Note 15:** Datasheet min/max specification limits are guaranteed by design, test, or statistical analysis.

**Note 16:** Number given is for an LQA028A package whose exposed-DAP is soldered to an exposed  $2.5in^2$  piece of 1 ounce PCB copper.

## MH and LQ Specific Characteristics

**LM4840MH, LM4840LQ**  
THD+N vs Output Power

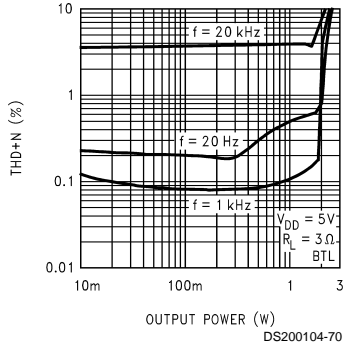

**LM4840MH, LM4840LQ**  
THD+N vs Frequency

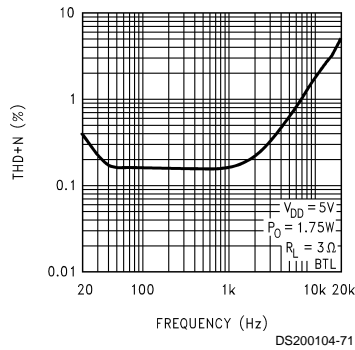

**LM4840MH, LM4840LQ**  
THD+N vs Output Power

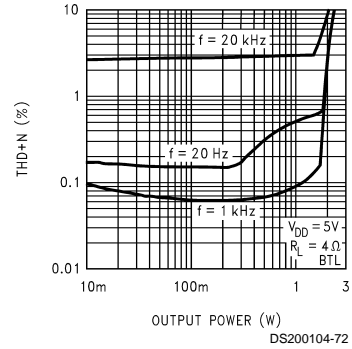

**LM4840MH, LM4840LQ**  
THD+N vs Frequency

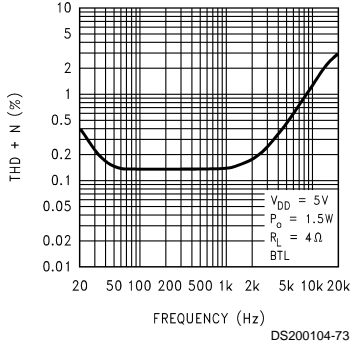

**LM4840MH, LM4840LQ**  
Power Dissipation vs Output Power

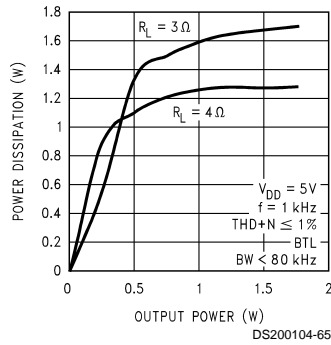

**LM4840MH (Note 17)**  
Power Derating Curve

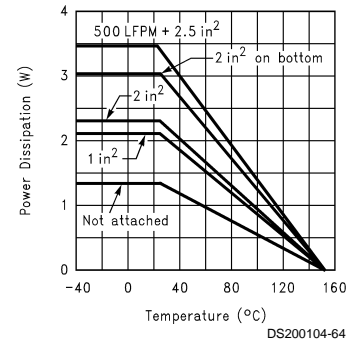

**Note 17:** These curves show the thermal dissipation ability of the LM4840MH at different ambient temperatures given these conditions:

- 500LFPM + 2in<sup>2</sup>:** The part is soldered to a 2in<sup>2</sup>, 1 oz. copper plane with 500 linear feet per minute of forced-air flow across it.
- 2in<sup>2</sup> on bottom:** The part is soldered to a 2in<sup>2</sup>, 1oz. copper plane that is on the bottom side of the PC board through 21 8 mil vias.
- 2in<sup>2</sup>:** The part is soldered to a 2in<sup>2</sup>, 1oz. copper plane.
- 1in<sup>2</sup>:** The part is soldered to a 1in<sup>2</sup>, 1oz. copper plane.
- Not Attached:** The part is not soldered down and is not forced-air cooled.

## Typical Performance Characteristics

**THD+N vs Frequency**

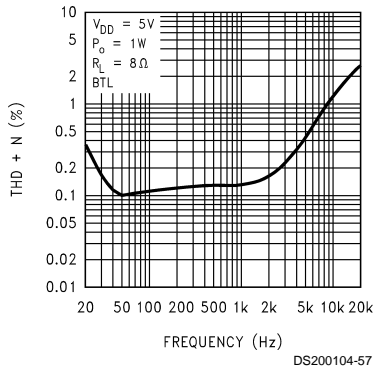

**THD+N vs Frequency**

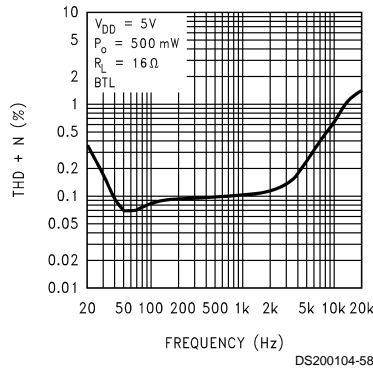

**THD+N vs Frequency**

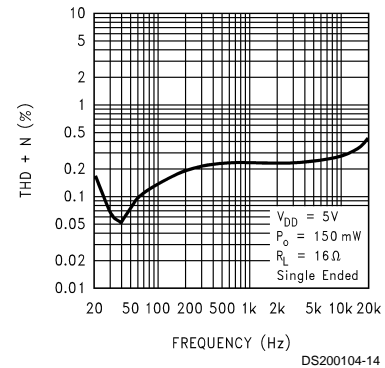

# Typical Performance Characteristics (Continued)

THD+N vs Frequency

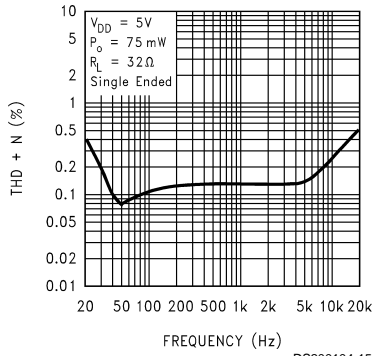

THD+N vs Frequency

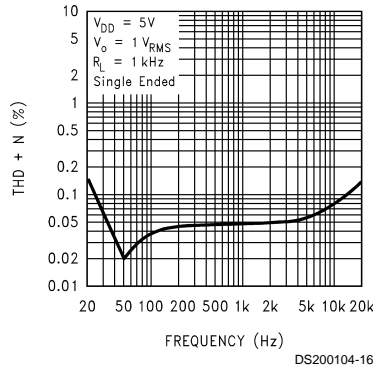

THD+N vs Frequency

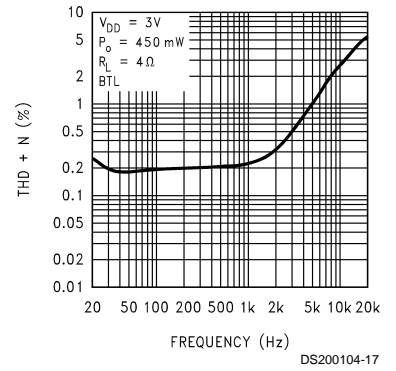

THD+N vs Frequency

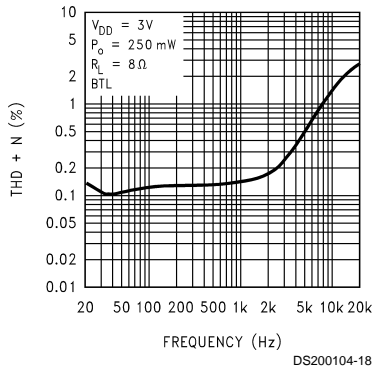

THD+N vs Frequency

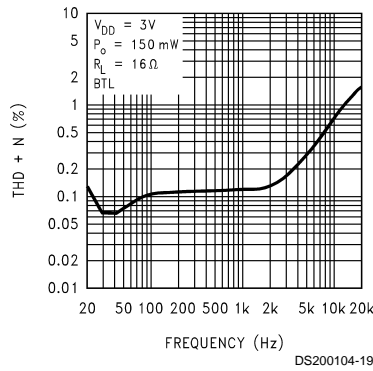

THD+N vs Frequency

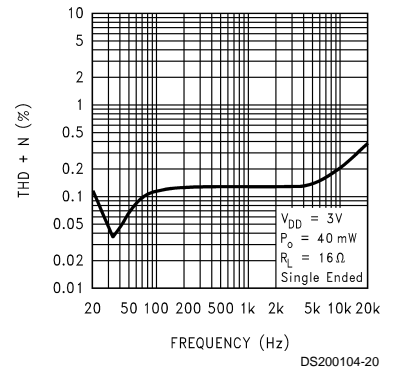

THD+N vs Frequency

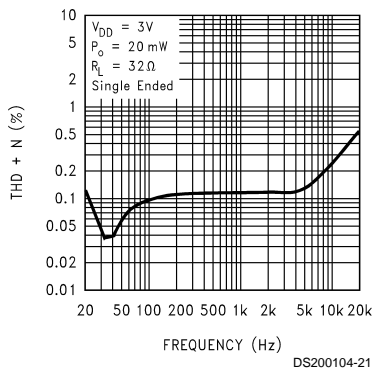

THD+N vs Frequency

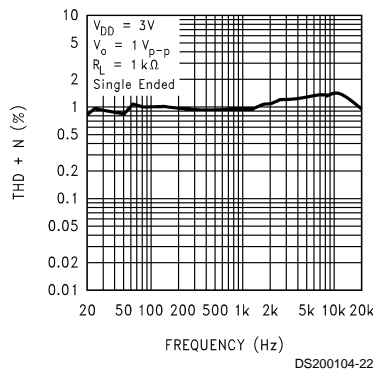

THD+N vs Output Power

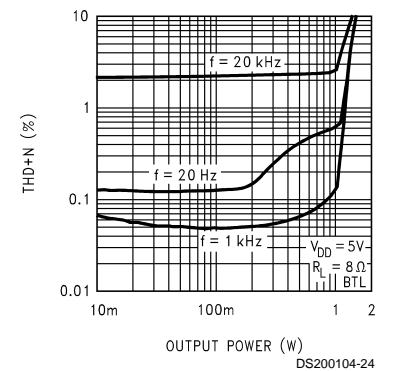

# Typical Performance Characteristics (Continued)

**THD+N vs Output Power**

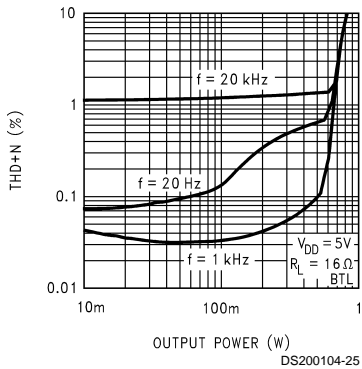

**THD+N vs Output Power**

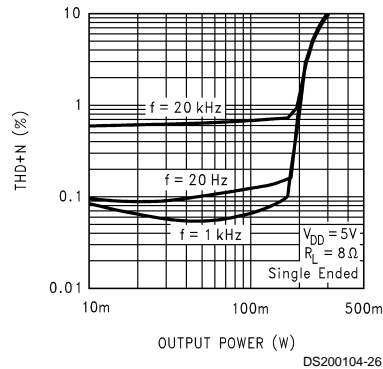

**THD+N vs Output Power**

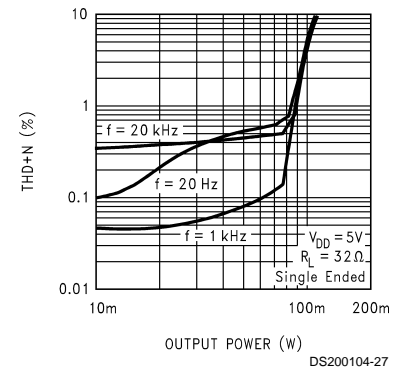

**THD+N vs Output Power**

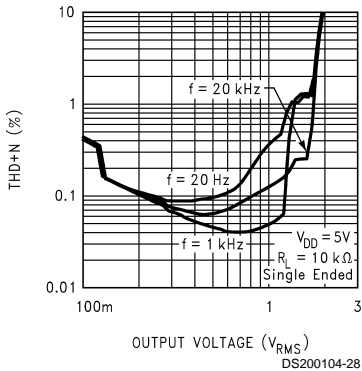

**THD+N vs Output Power**

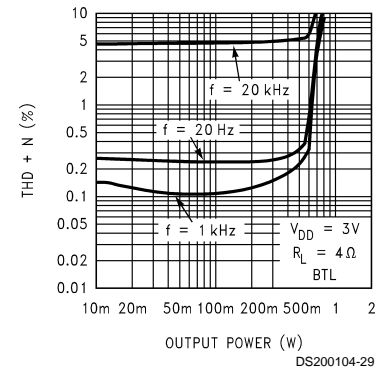

**THD+N vs Output Power**

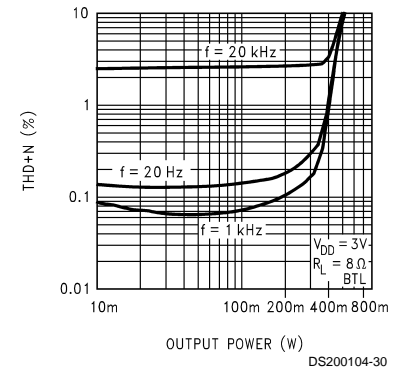

**THD+N vs Output Power**

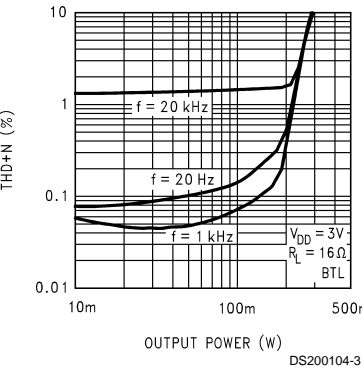

**THD+N vs Output Power**

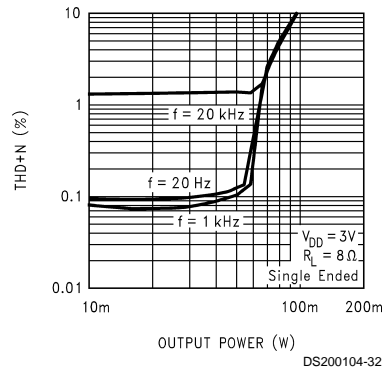

**THD+N vs Output Power**

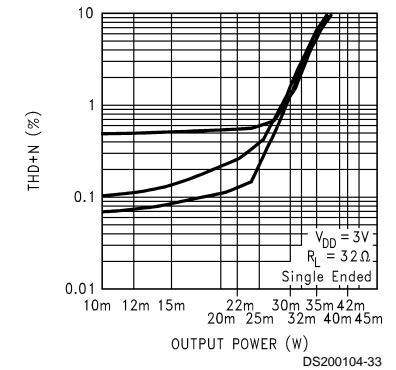

# Typical Performance Characteristics (Continued)

**THD+N vs Output Power**

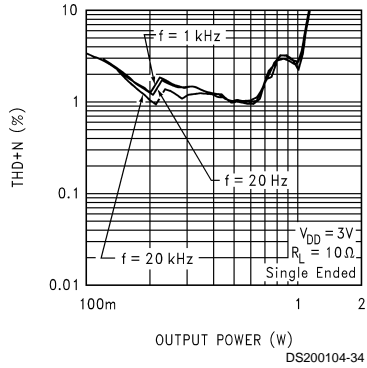

**Output Power vs Load Resistance**

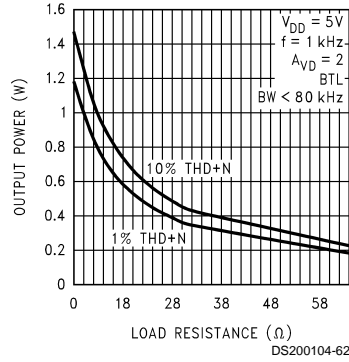

**Output Power vs Load Resistance**

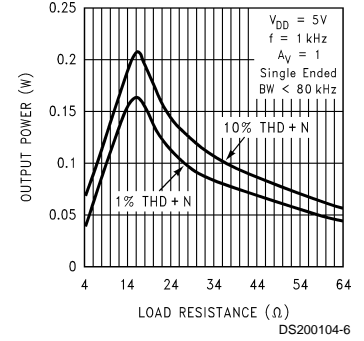

**Output Power vs Load Resistance**

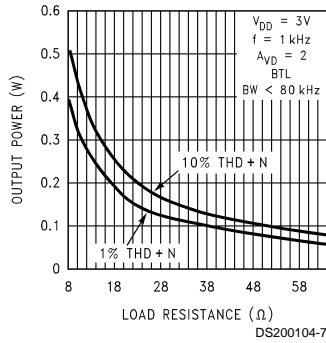

**Power Supply Rejection Ratio**

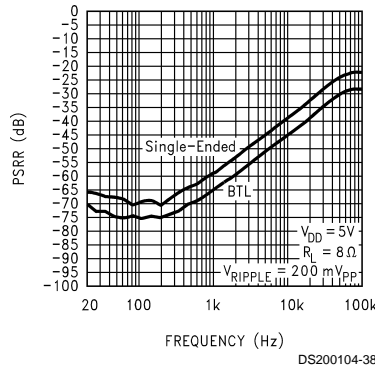

**Dropout Voltage**

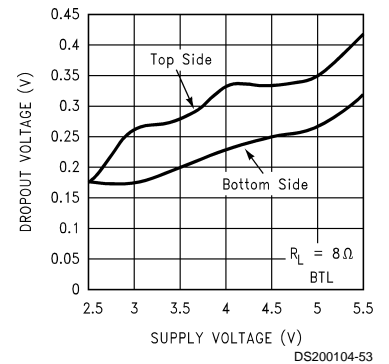

**Output Power vs Load Resistance**

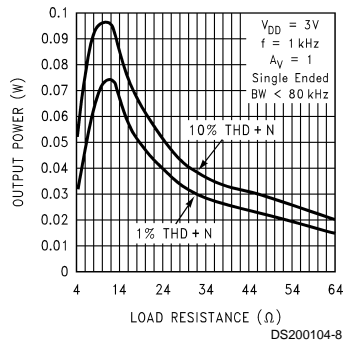

**Noise Floor**

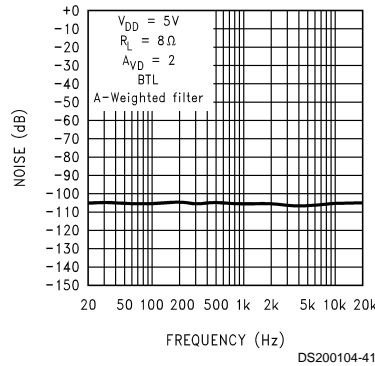

**Noise Floor**

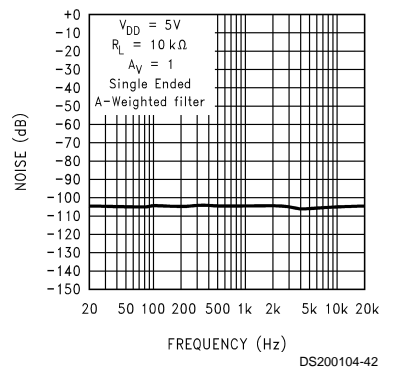

# Typical Performance Characteristics (Continued)

**Power Dissipation vs Output Power**

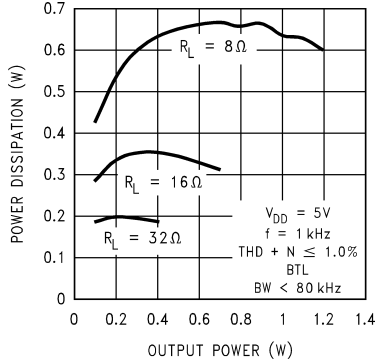

**Power Dissipation vs Output Power**

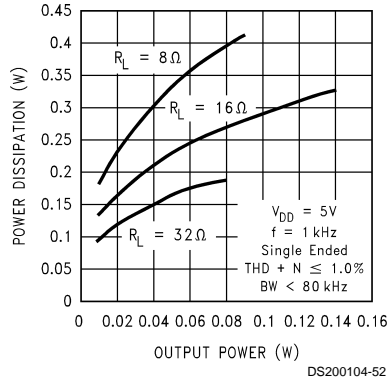

**Power Derating Curve**

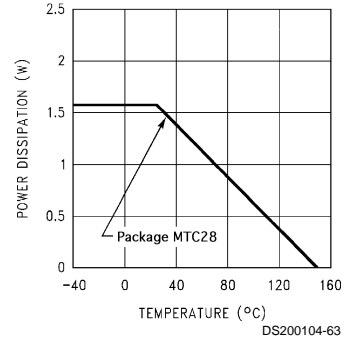

**Crosstalk**

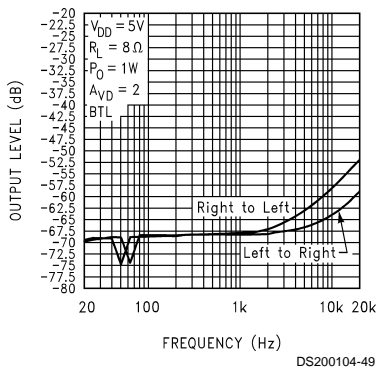

**Crosstalk**

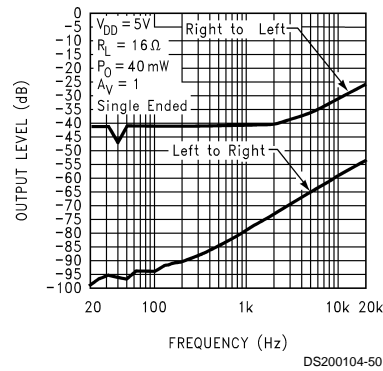

**Output Power vs Supply voltage**

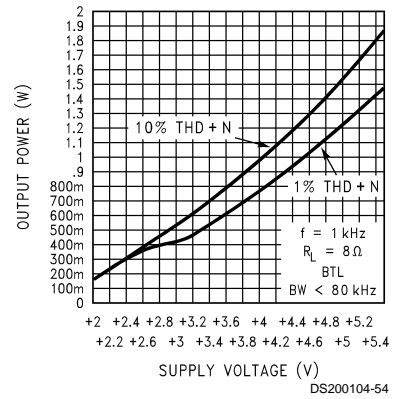

**Output Power vs Supply Voltage**

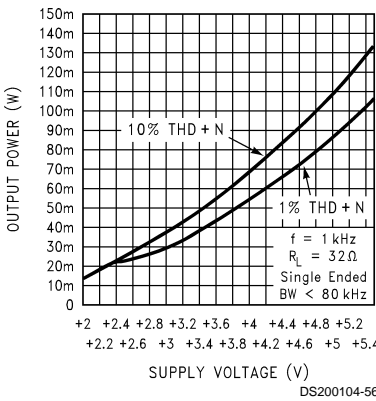

## Application Information

### DIGITAL VOLUME CONTROL

The LM4840 features a digital volume control which consists of the CLOCK, UP, and DOWN pins. An external clock may be fed to the CLOCK pin, or, by connecting a capacitor from the CLOCK pin to ground, the internal clock may be used. The internal clock frequency with respect to this capacitor value is determined from the following formula:

$$f_{\text{CLK}} = (7.338 \times 10^{-7}) / C$$

When using an external clock, the clock is buffered and the internal clock frequency is that of the external clock divided by 2. Also, the maximum frequency should be kept below 100kHz.

Volume changes are then effected by toggling either the UP or DOWN pins with a logic high. After a period of 4 clock pulses with either the UP or DOWN pins held high, the volume will change to the next specified step, either up or down. Volume levels for each step vary and are specified in Table 2. If either the UP or DOWN pin remains high after the first volume transition the volume will change again, but this time after 40 clock pulses. The next transition occurs at 20 clock pulses, then 12, then 8, and from then on 4 clock pulses for each volume transition. This cycle is shown in the timing diagram shown in Figure 3. Releasing the held UP or DOWN pin to ground at any time re-starts the cycle. This is intended to provide the user with a volume control that pauses briefly after initial application, then slowly increases the rate of volume change as it is continuously applied.

If both the UP and DOWN pins are held high, no volume change will occur. Trigger points for the UP and DOWN pins are at 60% of  $V_{\text{DD}}$  minimum for a logic high, and 20% of  $V_{\text{DD}}$  maximum for a logic low. It is recommended, however, to toggle UP and DOWN between  $V_{\text{DD}}$  and GND for best performance. When using an external clock, clock pulses should be a minimum of 3V for a high and maximum of 0.9V for a low when using a 5V supply. Again, pulsing an external clock from  $V_{\text{DD}}$  to GND ensures reliable performance. Following these guidelines the volume may then be changed with a microcontroller or manually using switches.

### MEMORY FUNCTION

The LM4840 features a volume memory that saves the last volume setting when power is turned off. This requires that an auxiliary power source be connected to  $V_{\text{AUX}}$  through a diode as shown in Figure 1. Connecting the circuit as shown also provides that power to the  $V_{\text{AUX}}$  pin is being drawn from  $V_{\text{DD}}$  when  $V_{\text{DD}}$  is on and is greater than  $V_{\text{AUX}}$ .  $V_{\text{AUX}}$  must be at a voltage of 2.3V or greater to maintain volume memory when  $V_{\text{DD}}$  is absent. This feature is intended for such applications as laptop computers, where  $V_{\text{DD}}$  is the system power and  $V_{\text{AUX}}$  is connected to the real time clock battery. The default volume setting for the LM4840 is -10dB in BTL mode, and -16dB in single-ended mode. This default setting is only achieved on power up when both  $V_{\text{DD}}$  and  $V_{\text{AUX}}$  had both been turned off, and the circuit had sufficient time to discharge (<500ms depending on capacitor value at  $V_{\text{AUX}}$ ).

### ELIMINATING OUTPUT COUPLING CAPACITORS

Typical single-supply audio amplifiers that can switch between driving bridge-tied-load (BTL) speakers and single-ended (SE) headphones use a coupling capacitor on each SE output. This capacitor blocks the half-supply voltage to which the output amplifiers are typically biased and

couples the audio signal to the headphones. The signal return to circuit ground is through the headphone jack's sleeve.

The LM4840 eliminates these coupling capacitors. Amp2A is internally configured to apply  $V_{\text{DD}}/2$  to a stereo headphone jack's sleeve. This voltage matches the quiescent voltage present on the Amp1A and Amp1B outputs that drive the headphones. The headphones operate in a manner very similar to a bridge-tied-load (BTL). The same DC voltage is applied to both headphone speaker terminals. This results in no net DC current flow through the speaker. AC current flows through a headphone speaker as an audio signal's output amplitude increases on the speaker's terminal.

When operating as a headphone amplifier, the headphone jack sleeve is not connected to circuit ground. Using the headphone output jack as a line-level output will place the LM4840's one-half supply voltage on a plug's sleeve connection. Driving a portable notebook computer or audio-visual display equipment is possible. This presents no difficulty when the external equipment uses capacitively coupled inputs. For the very small minority of equipment that is DC-coupled, the LM4840 monitors the current supplied by the amplifier that drives the headphone jack's sleeve. If this current exceeds  $500\text{mA}_{\text{PK}}$ , the amplifier is shutdown, protecting the LM4840 and the external equipment. For more information, see the section titled '**Single-Ended Output Power Performance and Measurement Considerations**'.

### EXPOSED-DAP MOUNTING CONSIDERATIONS

The LM4840's exposed-DAP (die attach paddle) packages (MH, LQ) provide a low thermal resistance between the die and the PCB to which the part is mounted and soldered. This allows rapid heat transfer from the die to the surrounding PCB copper traces, ground plane and, finally, surrounding air. The result is a low voltage audio power amplifier that produces 2W at  $\leq 1\%$  THD with a  $4\Omega$  load. This high power is achieved through careful consideration of necessary thermal design. Failing to optimize thermal design may compromise the LM4840's high power performance and activate unwanted, though necessary, thermal shutdown protection.

The MH and LQ packages must have their exposed DAPs soldered to a grounded copper pad on the PCB. The DAP's PCB copper pad is connected to a large plane of continuous unbroken copper. This plane forms a thermal mass and heat sink and radiation area. Place the heat sink area on either outside plane in the case of a two-sided PCB, or on an inner layer of a board with more than two layers. Connect the DAP copper pad to the inner layer or backside copper heat sink area with  $32(4 \times 8)$  (MH) or  $6(3 \times 2)$  (LQ) vias. The via diameter should be 0.012in–0.013in with a 1.27mm pitch. Ensure efficient thermal conductivity by plating-through and solder-filling the vias.

Best thermal performance is achieved with the largest practical copper heat sink area. If the heatsink and amplifier share the same PCB layer, a nominal  $2.5\text{in}^2$  (min) area is necessary for 5V operation with a  $4\Omega$  load. Heatsink areas not placed on the same PCB layer as the should be  $5\text{in}^2$  (min) for the same supply voltage and load resistance. The last two area recommendations apply for  $25^\circ\text{C}$  ambient temperature. Increase the area to compensate for ambient temperatures above  $25^\circ\text{C}$ . In systems using cooling fans, the LM4840MH can take advantage of forced air cooling. With an air flow rate of 450 linear-feet per minute and a  $2.5\text{in}^2$  exposed copper or  $5.0\text{in}^2$  inner layer copper plane heatsink, the LM4840MH can continuously drive a  $3\Omega$  load to full power. The LM4840LQ achieves the same output power

## Application Information (Continued)

level without forced air cooling. In all circumstances and conditions, the junction temperature must be held below 150°C to prevent activating the LM4840's thermal shutdown protection. The LM4840's power derating curve in the **Typical Performance Characteristics** shows the maximum power dissipation versus temperature. Further detailed and specific information concerning PCB layout, fabrication, and mounting an LQ (LLP) package is available in National Semiconductor's AN1187.

### POWER DISSIPATION

Power dissipation is a major concern when using any power amplifier and must be thoroughly understood to ensure a successful design. Equation 1 states the maximum power dissipation point for a single-ended amplifier operating at a given supply voltage and driving a specified load.

$$P_{\text{DMAX}} = (V_{\text{DD}})^2 / (2\pi^2 R_L) \quad (1)$$

However, a direct consequence of the increased power delivered to the load by a bridged amplifier is an increase in internal power dissipation. Equation 2 states the maximum power dissipation point for a bridged amplifier operating at a given supply voltage and driving a specified load.

$$P_{\text{DMAX}} = 4(V_{\text{DD}})^2 / (2\pi^2 R_L) \quad (2)$$

Since the LM4840 is a stereo power amplifier, the maximum internal power dissipation is two times that of Equation 1 or Equation 2 depending on the mode of operation. Even with the power dissipation of the stereo amplifiers, the LM4840 does not require heatsinking. The power dissipation from the amplifiers, must not be greater than the package power dissipation that results from Equation 3:

$$P_{\text{DMAX}} = (T_{\text{JMAX}} - T_{\text{A}}) / \theta_{\text{JA}} \quad (3)$$

For the LM4840 TSSOP package,  $\theta_{\text{JA}} = 80^\circ\text{C/W}$  and  $T_{\text{JMAX}} = 150^\circ\text{C}$ . Depending on the ambient temperature,  $T_{\text{A}}$ , of the system surroundings, Equation 3 can be used to find the maximum internal power dissipation supported by the IC packaging. If the result of Equation 1 and 2 is greater than that of Equation 3, then either the supply voltage must be decreased, the load impedance increased, or the ambient temperature reduced. For the typical application of a 5V power supply, with an  $8\Omega$  bridged loads, the maximum ambient temperature possible without violating the maximum junction temperature is approximately  $48^\circ\text{C}$  provided that device operation is around the maximum power dissipation points. Power dissipation is a function of output power and thus, if typical operation is not around the maximum power dissipation point, the ambient temperature can be increased. Refer to the **Typical Performance Characteristics** curves for power dissipation information for different output powers.

### LAYOUT

As stated in the Grounding section, placement of ground return lines is imperative in maintaining the highest level of system performance. It is not only important to route the correct ground return lines together, but also to be aware of where the ground return lines are routed with respect to each other. The output load ground returns should be physically located as far as possible from low signal level lines and their ground return lines.

### 3Ω and 4Ω Layout Considerations

With low impedance loads, the output power at the loads is heavily dependent on trace resistance from the output pins of the LM4840. Traces from the output of the LM4840MH to

the load or load connectors should be as wide as practical. Any resistance in the output traces will reduce the power delivered to the load. For example, with a  $4\Omega$  load and  $0.1\Omega$  of trace resistance in each output, output power at the load drops from 2W to 1.8W.

Output power is also dependent on supply regulation. To keep the supply voltage from sagging under full output conditions, the supply traces should be as wide as practical.

### Grounding

In order to achieve the best possible performance, there are certain grounding techniques to be followed. All input reference grounds should be tied with their respective source grounds and brought back to the power supply ground separately from the output load ground returns. Bringing the ground returns for the output loads back to the supply separately will keep large signal currents from interfering with the stable AC input ground references. The exposed-DAP of the LM4840MH package must be tied to ground.

### POWER SUPPLY BYPASSING

As with any power amplifier, proper supply bypassing is critical for low noise performance and high power supply rejection. The capacitor location on both the bypass and power supply pins should be as close to the device as possible. The effect of a larger half supply bypass capacitor is improved PSRR due to increased half-supply stability. Typical applications employ a 5 volt regulator with  $10\mu\text{F}$  and a  $0.1\mu\text{F}$  bypass capacitors which aid in supply stability, but do not eliminate the need for bypassing the supply nodes of the LM4840. The selection of bypass capacitors, especially  $C_{\text{B1}}$ , is thus dependant upon desired PSRR requirements, click and pop performance as explained in the section, **Proper Selection of External Components**, system cost, and size constraints. It is also recommended to decouple each of the  $V_{\text{DD}}$  pins with a  $0.1\mu\text{F}$  capacitor to ground.

### PROPER SELECTION OF EXTERNAL COMPONENTS

Proper selection of external components in applications using integrated power amplifiers is critical to optimize device and system performance. While the LM4840 is tolerant of external component combinations, consideration to component values must be used to maximize overall system quality.

The LM4840's bridged amplifier should be used in low gain configurations to minimize THD+N values, and maximize the signal to noise ratio. Low gain configurations require large input signals to obtain a given output power. Input signals equal to or greater than 1Vrms are available from sources such as audio codecs.

Besides gain, one of the major considerations is the closed-loop bandwidth of the amplifier. To a large extent, the bandwidth is dictated by the choice of external components. Both the input coupling capacitor,  $C_i$ , and the output coupling capacitor form first order high pass filters which limit low frequency response given in Equations 4 and 5.

$$f_{\text{IC}} = 1 / (2\pi R_i C_i) \quad (4)$$

$$f_{\text{OC}} = 1 / (2\pi R_L C_O) \quad (5)$$

These values should be chosen based on required frequency response.

### Selection of Input and Output Capacitor Size

Large input and output capacitors are both expensive and space hungry for portable designs. Clearly, a certain sized capacitor is needed to couple in low frequencies without

## Application Information (Continued)

severe attenuation. In many cases the speakers used in portable systems, whether internal or external, have little ability to reproduce signals below 100 Hz–150 Hz. In this case, using a large input or output capacitor may not increase system performance.

In addition to system cost and size, click and pop performance is effected by the size of the input coupling capacitor,  $C_i$ . A larger input coupling capacitor requires more charge to reach its quiescent DC voltage (nominally  $1/2 V_{DD}$ .) This charge comes from the output through the feedback and is apt to create pops once the device is enabled. By minimizing the capacitor size based on necessary low frequency response, turn-on pops can be minimized.

### CLICK AND POP CIRCUITRY

The LM4840 contains circuitry to minimize turn-on transients or “click and pops”. In this case, turn-on refers to either power supply turn-on or the device coming out of shutdown mode. When the device is turning on, the amplifiers are internally muted. An internal current source ramps up the voltage of the bypass pin. Both the inputs and outputs ideally track the voltage at the bypass pin. The device will remain in mute mode until the bypass pin has reached its half supply voltage,  $1/2 V_{DD}$ . As soon as the bypass node is stable, the device will become fully operational.

Although the bypass pin current source cannot be modified, the size of the bypass capacitor,  $C_B$ , can be changed to alter the device turn-on time and the amount of “click and pop”. By increasing  $C_B$ , the amount of turn-on pop can be reduced. However, the trade-off for using a larger bypass capacitor is an increase in the turn-on time for the device. Reducing  $C_B$  will decrease turn-on time and increase “click and pop”.

There is a linear relationship between the size of  $C_B$  and the turn-on time. Here are some typical turn-on times for different values of  $C_B$ :

$C_B$	$T_{ON}$
0.01 $\mu\text{F}$	2 ms
0.1 $\mu\text{F}$	20 ms
0.22 $\mu\text{F}$	42 ms
0.47 $\mu\text{F}$	84 ms
1.0 $\mu\text{F}$	200 ms
4.7 $\mu\text{F}$	1sec

In order to eliminate “click and pop”, all capacitors must be discharged before turn-on. Rapid on/off switching of the device or shutdown function may cause the “click and pop” circuitry to not operate fully, resulting in increased “click and pop” noise.

### DOCKING STATION

In an application such as a notebook computer, docking station or line level outputs may be required. Pin 9 and Pin 13 can drive loads greater than  $1\text{k}\Omega$  rail to rail. These pins are tied to the output of the input op-amp to drive powered speakers and other high impedance loads. Output coupling capacitors need to be placed in series with the load. The recommended values of the capacitors are between  $0.33\mu\text{F}$  to  $1.0\mu\text{F}$  with the positive side of the capacitors toward the IC. The outputs of the docking station pins cannot be attenuated with the DC volume control. However the gain of the

outputs can be configured by adjusting the feedback and input resistors for the input op-amp. The input op-amp is in an inverting configuration where the gain is:

$$R_F / R_i = -A_V$$

Note that by adjusting the gain of the input op-amp the overall gain of the output amplifiers are also affected. Although the single ended outputs of the output amplifiers can be used to drive line level outputs, it is recommended to use Pins 9 and 13 to achieve better performance.

### BEEP DETECT FUNCTION

The Beep Detect pin (Beep In) is a mono input that detects the presence of a beep signal. When a signal greater than  $2.5V_{P-P}$  (or  $1/2 V_{DD}$ ) is present at Beep In, the Beep Detect circuitry will enable the bridged amplifiers. Beep In signals less than  $2.5V_{P-P}$  (or  $1/2 V_{DD}$ ) will not trigger the Beep Detect circuitry. When triggered, the Beep Detect circuitry will enable the bridged amplifiers regardless of the state of the mute, mode, or HP sense pins. As shown in the Fig. 1, a  $200\text{k}\Omega$  resistor is placed in series with the input capacitor. This  $200\text{k}\Omega$  resistor can be changed to vary the amplitude of the beep in signal. Higher values of the resistor will reduce the amplifier gain and attenuate the beep in signal. These resistors are required in order for the beep signal to pass to the output. The Beep Detect pin will not pass the beep signal to the output. In cases where system beeps are required when the system is in a suspended mode, the LM4840 must be brought out of shutdown before the beep in signal is input.

### SHUTDOWN FUNCTION

In order to reduce power consumption while not in use, the LM4840 contains a shutdown pin to externally turn off the bias circuitry. The LM4840 will shutdown when a logic high is placed on the shutdown pin. The trigger point between a logic low and logic high level is typically half supply. It is best to switch between ground and the supply  $V_{DD}$  to provide maximum device performance. By switching the shutdown pin to  $V_{DD}$ , the LM4840 supply current draw will be minimized. While the device will be disabled with shutdown pin voltages less than  $V_{DD}$ , the idle current may be greater than the typical value of  $0.7\mu\text{A}$ . The shutdown pin should not be floated, since this may result in an unwanted shutdown condition.

In many applications, a microcontroller or microprocessor output is used to control the shutdown circuitry which provides a quick, smooth transition into shutdown. Another solution is to use a single-pole, single-throw switch in conjunction with an external pull-up resistor. When the switch is closed, the shutdown pin is connected to ground and enables the amplifier. If the switch is open, then the external pull-up resistor will shutdown the LM4840. This scheme prevents the shutdown pin from floating.

### HP-IN FUNCTION

An internal pull-up circuit is connected to the HP–Sense headphone amplifier control pin. When this pin is left unconnected,  $V_{DD}$  is applied to the HP–Sense. This turns off Amp2B and switches Amp2A's input signal from an audio signal to the  $V_{DD}/2$  voltage present on Bypass. The result is muted bridge-connected loads. Quiescent current consumption is reduced when the IC is in this single-ended mode.

Figure 2 shows the implementation of the LM4840's headphone control function. An internal comparator with a nominal  $400\text{mV}$  offset monitors the signal present at the –OUTB output. It compares this signal against the signal applied to the HP–Sense pin. When these signals are equal, as is the

### Application Information (Continued)

case when a BTL is connected to the amplifier, the comparator forces the LM4840 to maintain bridged-amplifier operation. When the HP-Sense pin is externally floated, such as when headphones are connected to the jack shown in *Figure 2*, and internal pull-up forces  $V_{DD}$  on the internal comparator's HP-Sense inputs. This changes the comparator's output state and enables the headphone function: it turns off Amp2B, switches Amp2A's input signal from an audio signal to the  $V_{DD}/2$  voltage present on pin 14, and mutes the bridge-connected loads. Amp1A and Amp1B drive the headphones.

*Figure 2* also shows the suggested headphone jack electrical connections. The jack is designed to mate with a

three-wire plug. The plug's tip and ring should each carry one of the two stereo output signals, whereas the sleeve provides the return to Amp2A. A headphone jack with one control pin contact is sufficient to drive the HP-Sense pin when connecting headphones.

A switch can replace the headphone jack contact pin. When a switch shorts the HP-Sense pin to  $V_{DD}$ , bridge-connected speakers are muted and Amp1A and Amp2A drive a pair of headphones. When a switch shorts the HP-Sense pin to GND, the LM4840 operates in bridge mode. If headphone drive is not needed, short the HP-Sense pin to the -OUTB pin.

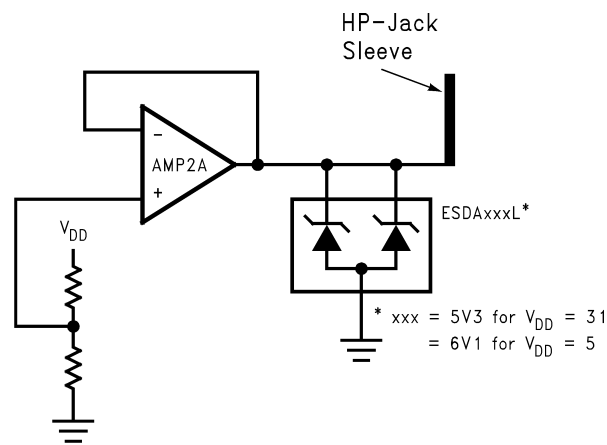

DS200104-74

**FIGURE 2. The ESDAxxxL provides additional ESD protection beyond the 8000V shown in the Absolute Maximum Ratings for the AMP2A output**

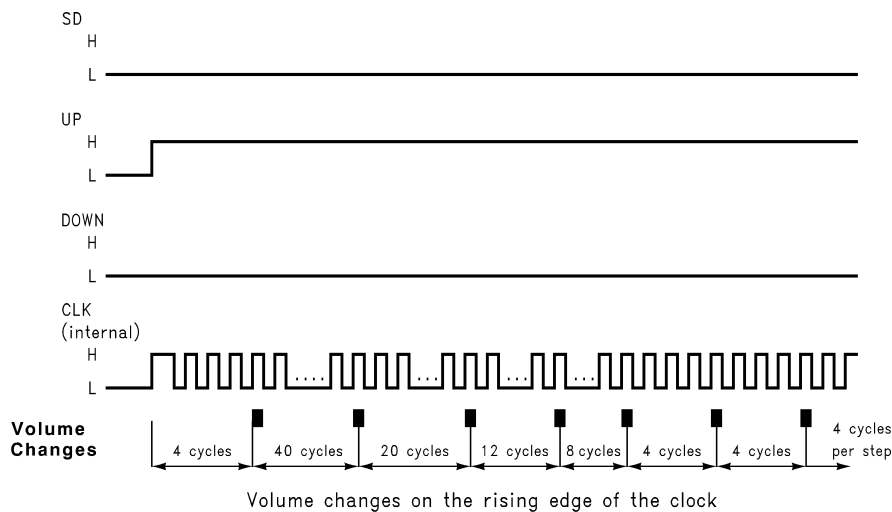

DS200104-75

**FIGURE 3. Volume Control Timing Diagram**

## Application Information (Continued)

### Table 1: Logic Level Truth Table

SD	BEEP DETECT	MUTE	HP SENSE	MODE	R-	R+	L-	L+	
L	L	L	L	BTL SPK	ON	ON	ON	ON	
L	L	L	H	HP	ON	ON (buffer)	ON	OFF	
L	L	H	L	BTLSPK	ON	ON	ON	ON	*Amps are muted
L	L	H	H	HP	ON	ON (buffer)	ON	OFF	*Amps are muted
*Next four conditions, beep is detected; beep signal added to audio signal and bypasses volume control (unity)									
L	H	L	L	BTL SPK	ON	ON	ON	ON	
L	H	L	H	HP	ON	ON (buffer)	ON	ON	
L	H	H	L	BTL SPK	ON	ON	ON	ON	*Dual Mode
L	H	H	H	HP	ON	ON (buffer)	ON	ON	*Dual Mode
*Next eight conditions turns off all amps									
H	L	L	L	BTL SPK	OFF	OFF	OFF	OFF	
H	L	L	H	HP	OFF	OFF	OFF	OFF	
H	L	H	L	BTL SPK	OFF	OFF	OFF	OFF	
H	L	H	H	HP	OFF	OFF	OFF	OFF	
H	H	L	L	BTL SPK	OFF	OFF	OFF	OFF	
H	H	L	H	HP	OFF	OFF	OFF	OFF	
H	H	H	L	BTL SPK	OFF	OFF	OFF	OFF	
H	H	H	H	HP	OFF	OFF	OFF	OFF	

\*Beepdetect signal overrides any mute. For example, if amp is muted and bpdetect is HIGH, then amp is no longer muted.

\*\*Dual mode: When HP jack is inserted, load A (speaker corresponding to outputs A- and A+) is physically disconnected. Load B remains connected; however, amp B+ is off and differentially there is no voltage across it. If a beep is detected (i.e. beepdetect = HIGH), then summed signal (audio + beep signals) is heard in the headphones and on speaker B.

## Application Information (Continued)

### Table 2: LM4840 Volume Control Steps

Volume Step	BTL (dB)	SE (dB)
1	6.00	0.00
2	5.00	-1.00
3	4.00	-2.00
4	3.00	-3.00
5	2.00	-4.00
6	1.00	-5.00
7	0.00	-6.00
8	-2.00	-8.00
9	-4.00	-10.00
10	-6.00	-12.00
11	-8.00	-14.00
<b>12</b>	<b>-10.00</b>	<b>-16.00</b>
13	-12.00	-18.00
14	-14.00	-20.00
15	-16.00	-22.00
16	-18.00	-24.00
17	-20.00	-26.00
18	-21.90	-27.90
19	-24.00	-30.00
20	-26.10	-32.10
21	-28.10	-34.10
22	-29.90	-35.90
23	-32.70	-38.70
24	-36.00	-42.00
25	-38.80	-44.80
26	-41.30	-47.30
27	-44.90	-50.90
28	-50.90	-56.90
29	-56.90	-62.90
30	-62.90	-68.90
31	-70.90	-76.90
32	-70.90	-76.90

**Physical Dimensions** inches (millimeters) unless otherwise noted

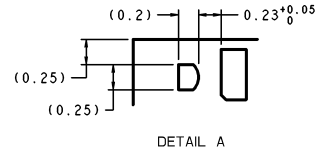
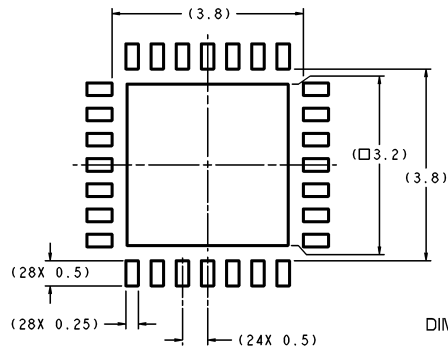

DIMENSIONS ARE IN MILLIMETERS

RECOMMENDED LAND PATTERN  
 1:1 RATION WITH PKG SOLDER PADS

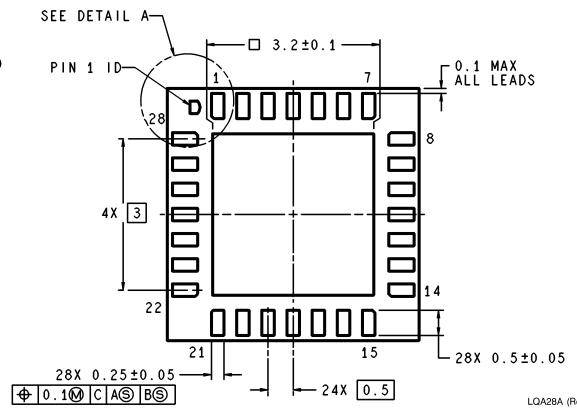
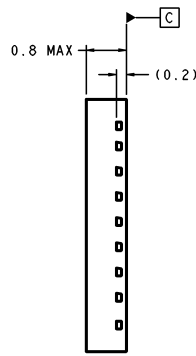
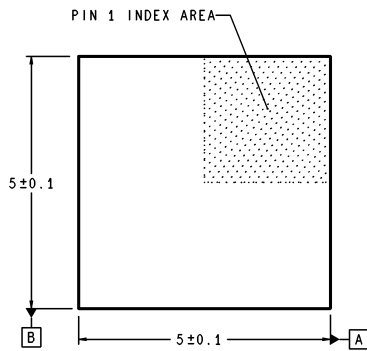

LQA28A (Rev B)

**LLP Package**  
**Order Number LM4840LQ**  
**NS Package Number LQA028A for Exposed-DAP LLP**



**Physical Dimensions** inches (millimeters) unless otherwise noted (Continued)

DIMENSIONS ARE IN MILLIMETERS

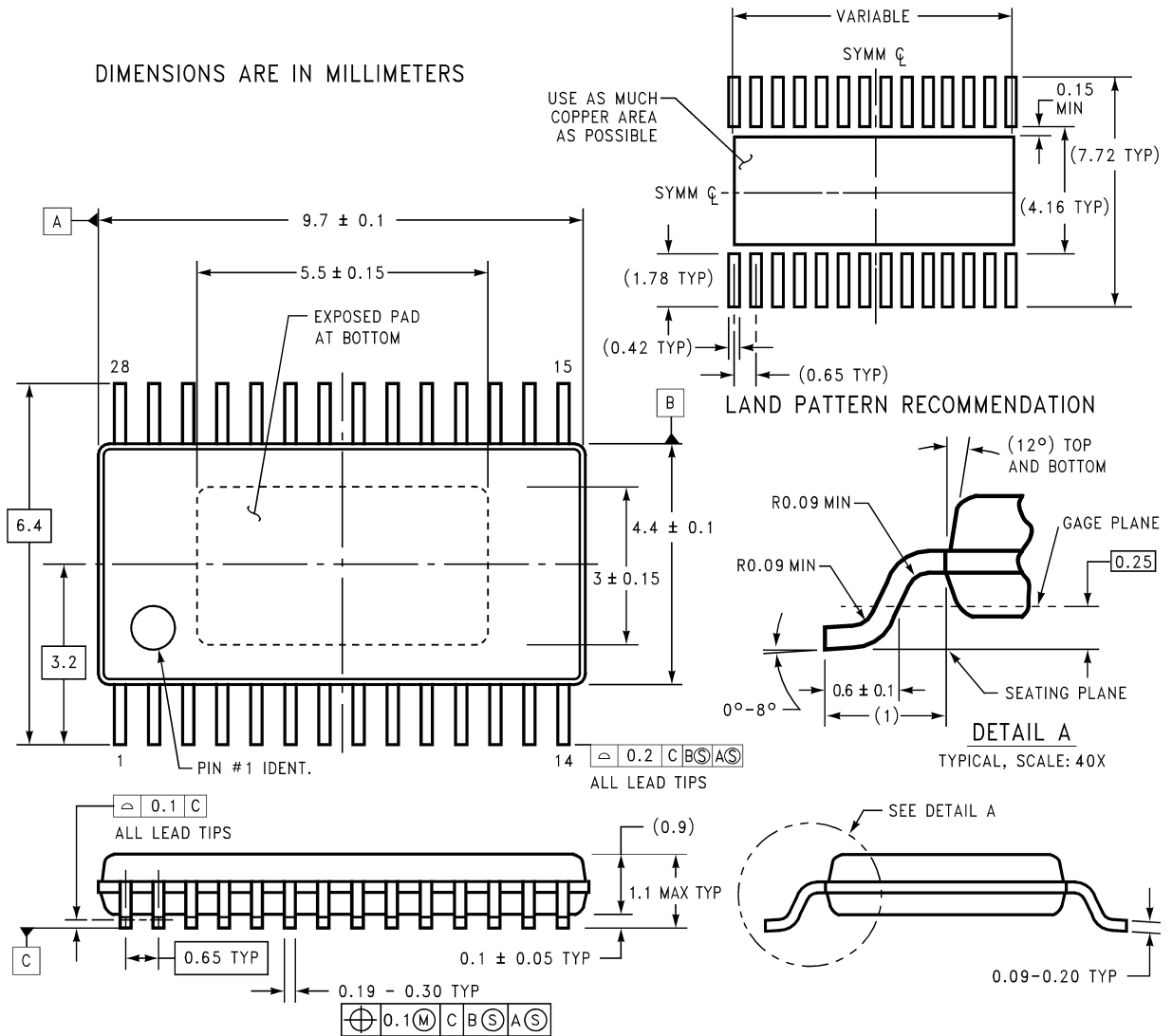

**Exposed-DAP TSSOP Package**  
**Order Number LM4840MH**  
**NS Package Number MXA28A for Exposed-DAP TSSOP**

MXA28A (REV A)

## Notes

### LIFE SUPPORT POLICY

NATIONAL'S PRODUCTS ARE NOT AUTHORIZED FOR USE AS CRITICAL COMPONENTS IN LIFE SUPPORT DEVICES OR SYSTEMS WITHOUT THE EXPRESS WRITTEN APPROVAL OF THE PRESIDENT AND GENERAL COUNSEL OF NATIONAL SEMICONDUCTOR CORPORATION. As used herein:

1. Life support devices or systems are devices or systems which, (a) are intended for surgical implant into the body, or (b) support or sustain life, and whose failure to perform when properly used in accordance with instructions for use provided in the labeling, can be reasonably expected to result in a significant injury to the user.
2. A critical component is any component of a life support device or system whose failure to perform can be reasonably expected to cause the failure of the life support device or system, or to affect its safety or effectiveness.



**National Semiconductor Corporation**  
Americas  
Email: support@nsc.com

[www.national.com](http://www.national.com)

**National Semiconductor Europe**

Fax: +49 (0) 180-530 85 86  
Email: europe.support@nsc.com  
Deutsch Tel: +49 (0) 69 9508 6208  
English Tel: +44 (0) 870 24 0 2171  
Français Tel: +33 (0) 1 41 91 8790

**National Semiconductor Asia Pacific Customer Response Group**

Tel: 65-2544466  
Fax: 65-2504466  
Email: ap.support@nsc.com

**National Semiconductor Japan Ltd.**

Tel: 81-3-5639-7560  
Fax: 81-3-5639-7507