

CEP603ALS2/CEB603ALS2

ELECTRICAL CHARACTERISTICS (Tc=25°C unless otherwise noted)

Parameter	Symbol	Condition	Min	Typ	Max	Unit
OFF CHARACTERISTICS						
Drain-Source Breakdown Voltage	BV _{DSS}	V _{GS} =0V, I _D =250μA	30			V
Zero Gate Voltage Drain Current	I _{DSS}	V _{DS} =24V, V _{GS} =0V			10	μA
Gate-Body Leakage	I _{GSS}	V _{GS} =±20V, V _{DS} =0V			±100	nA
ON CHARACTERISTICS^a						
Gate Threshold Voltage	V _{GS(th)}	V _{DS} =V _{GS} , I _D =250μA	1	1.6	3	V
Drain-Source On-State Resistance	R _{DS(ON)}	V _{GS} =10V, I _D =25A		16	22	mΩ
		V _{GS} =4.5V, I _D =10A		24	40	mΩ
On-State Drain Current	I _{D(ON)}	V _{GS} =10V, V _{DS} =10V	60			A
Forward Transconductance	g _{FS}	V _{DS} =10V, I _D =25A		35		S
DYNAMIC CHARACTERISTICS^b						
Input Capacitance	C _{ISS}	V _{DS} =15V, V _{GS} =0V f=1.0MHz		920	1200	pF
Output Capacitance	C _{OSS}			540	700	pF
Reverse Transfer Capacitance	C _{RSS}			230	300	pF
SWITCHING CHARACTERISTICS^b						
Turn-On Delay Time	t _{D(ON)}	V _{DD} =15V, I _D =25A, V _{GS} =10V, R _{GEN} =24Ω		20	23	ns
Rise Time	t _r			70	110	ns
Turn-Off Delay Time	t _{D(OFF)}			90	150	ns
Fall Time	t _f			85	130	ns
Total Gate Charge	Q _g	V _{DS} =10V, I _D =25A, V _{GS} =10V		21	40	nC
Gate-Source Charge	Q _{gs}			6		nC
Gate-Drain Charge	Q _{gd}			2		nC



CEP603ALS2/CEB603ALS2

BODY DIODE & SCHOTTKY DIODE RATINGS AND CHARACTERISTICS

Parameter	Symbol	Condition	Min	Typ	Max	Unit
DRAIN-SOURCE DIODE CHARACTERISTICS ^a						
Body Diode Forward Voltage	V_{SD}	$V_{GS} = 0V, I_S = 25A$			1.3	V
Schottky Forward Voltage	V_F	$I_F = 2A, T_C = 25^\circ C$			0.55	V
Average Forward Rectified Current	$I_{F(AV)}$				2	A

Notes

- a. Pulse Test: Pulse Width $\leq 300 \mu s$, Duty Cycle $\leq 2\%$.
- b. Guaranteed by design, not subject to production testing.

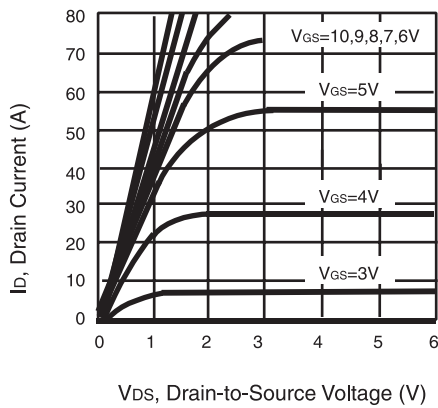

Figure 1. Output Characteristics

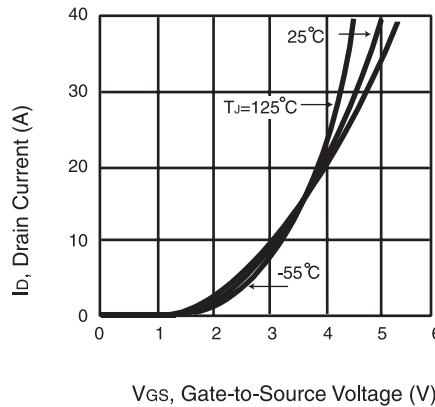

Figure 2. Transfer Characteristics

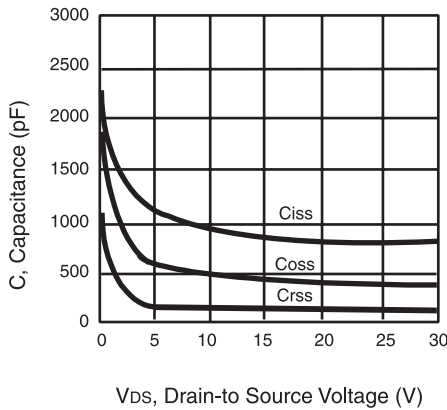

Figure 3. Capacitance

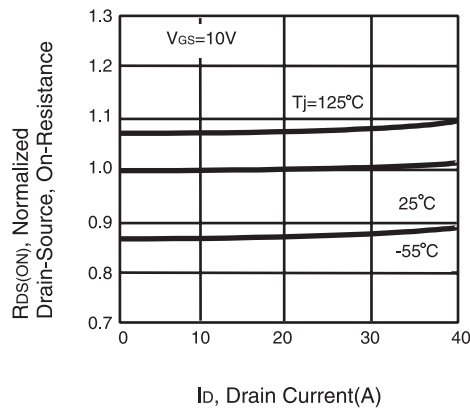

Figure 4. On-Resistance Variation with Drain Current and Temperature

CEP603ALS2/CEB603ALS2

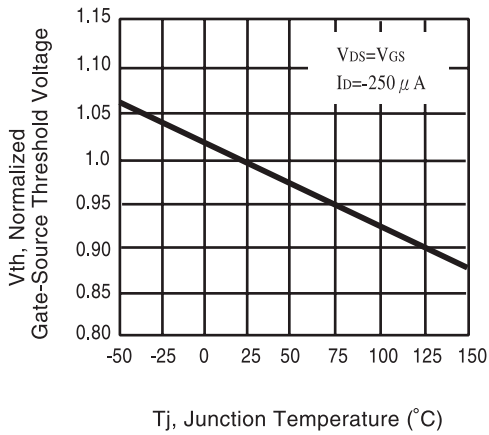

Figure 5. Gate Threshold Variation with Temperature

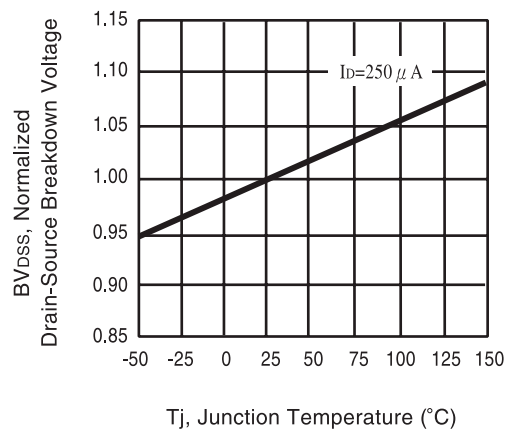

Figure 6. Breakdown Voltage Variation with Temperature

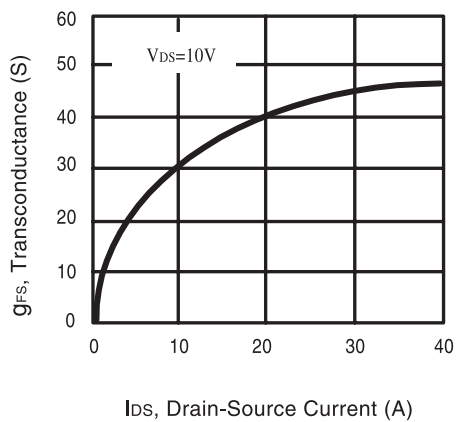

Figure 7. Transconductance Variation with Drain Current

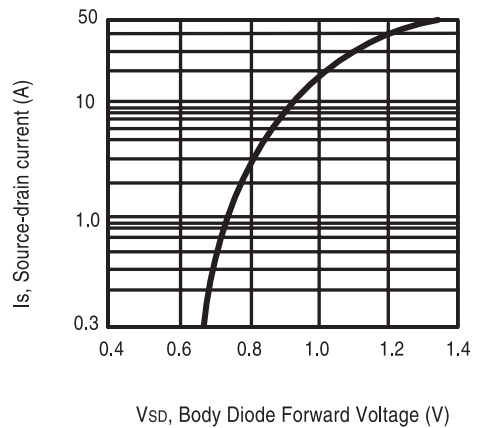

Figure 8. Body Diode Forward Voltage Variation with Source Current

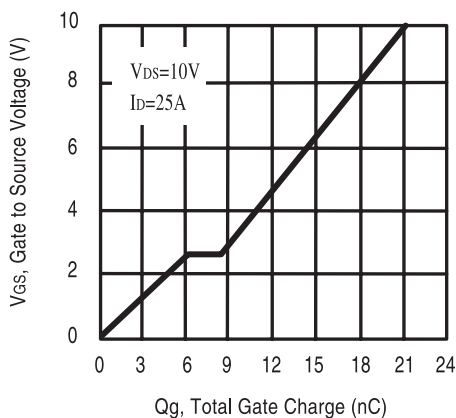

Figure 9. Gate Charge

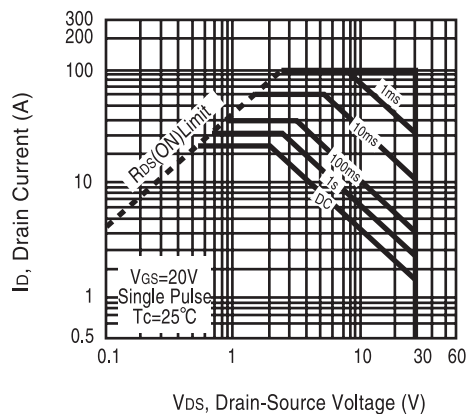
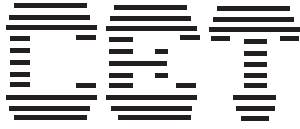

Figure 10. Maximum Safe Operating Area



CEP603ALS2/CEB603ALS2

March 1998

N-Channel Logic Level Enhancement Mode Field Effect Transistor

FEATURES

- 30V , 25A , $R_{DS(ON)}=22m\Omega$ @ $V_{GS}=10V$.
 $R_{DS(ON)}=40m\Omega$ @ $V_{GS}=4.5V$.
- Super high dense cell design for extremely low $R_{DS(ON)}$.
- High power and current handling capability.
- TO-220 & TO-263 package.

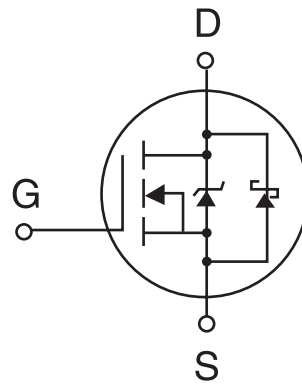

ABSOLUTE MAXIMUM RATINGS ($T_c=25^\circ C$ unless otherwise noted)

Parameter	Symbol	Limit	Unit
Drain-Source Voltage	V_{DS}	30	V
Gate-Source Voltage	V_{GS}	± 20	V
Drain Current-Continuous @ $T_J=125^\circ C$ -Pulsed	I_D	25	A
	I_{DM}	100	A
Drain-Source Diode Forward Current	I_S	25	A
Maximum Power Dissipation @ $T_c=25^\circ C$ Derate above $25^\circ C$	P_D	50	W
		0.4	W/ $^\circ C$
Operating and Storage Temperature Range	T_J, T_{STG}	-65 to 175	$^\circ C$

15

THERMAL CHARACTERISTICS

Thermal Resistance, Junction-to-Case	$R_{\theta JC}$	3	$^\circ C/W$
Thermal Resistance, Junction-to-Ambient	$R_{\theta JA}$	62.5	$^\circ C/W$

CEP603ALS2/CEB603ALS2

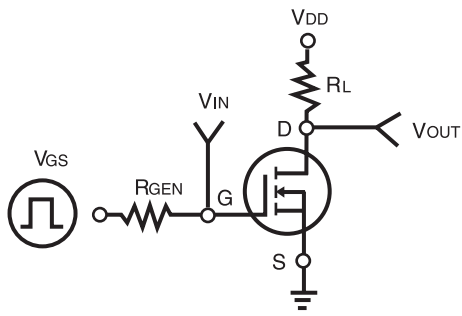

Figure 11. Switching Test Circuit

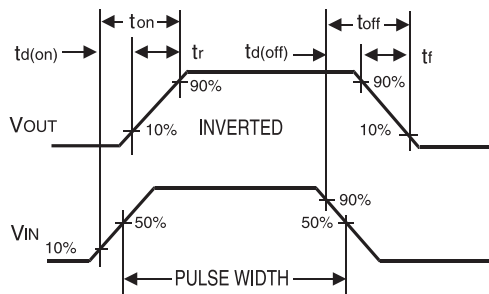

Figure 12. Switching Waveforms

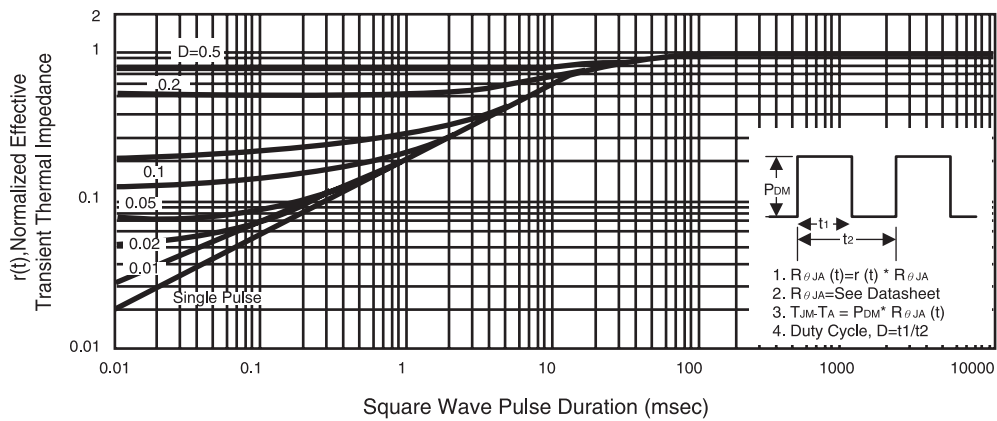

Figure 13. Normalized Thermal Transient Impedance Curve