

SWITCHING APPLICATION.  
INTERFACE CIRCUIT AND DRIVER CIRCUIT APPLICATION.

### FEATURES

- With Built-in Bias Resistors.
- Simplify Circuit Design.
- Reduce a Quantity of Parts and Manufacturing Process.
- High Packing Density.

### EQUIVALENT CIRCUIT

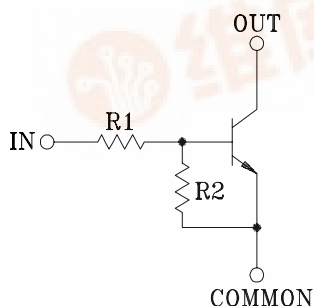

### BIAS RESISTOR VALUES

TYPE NO.	R1(kΩ)	R2(kΩ)
KRC401	4.7	4.7
KRC402	10	10
KRC403	22	22
KRC404	47	47
KRC405	2.2	47
KRC406	4.7	47

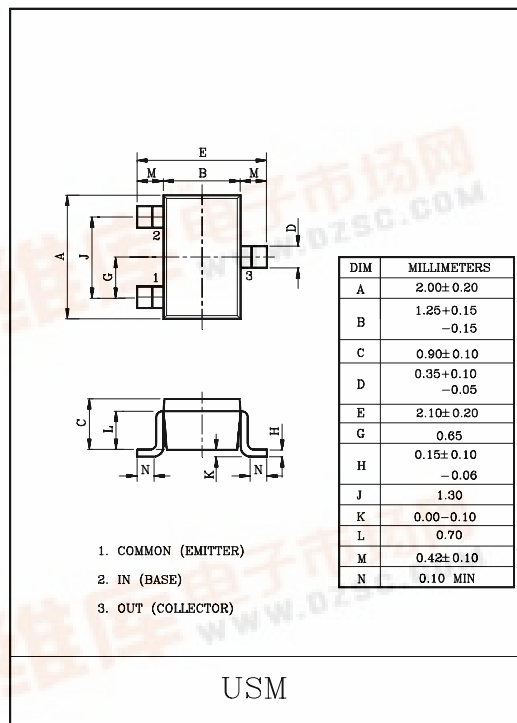

### MAXIMUM RATINGS (Ta=25°C)

CHARACTERISTIC		SYMBOL	RATING	UNIT
Output Voltage	KRC401 ~406	V <sub>o</sub>	50	V
Input Voltage	KRC401	V <sub>i</sub>	20, -10	V
	KRC402		30, -10	
	KRC403		40, -10	
	KRC404		40, -10	
	KRC405		12, -5	
	KRC406		20, -5	
Output Current	KRC401 ~406	I <sub>o</sub>	100	mA
Power Dissipation		P <sub>D</sub>	100	mW
Junction Temperature		T <sub>j</sub>	150	°C
Storage Temperature Range		T <sub>stg</sub>	-55~150	°C

### MARK SPEC

TYPE	KRC401	KRC402	KRC403	KRC404	KRC405	KRC406
MARK	NA	NB	NC	ND	NE	NF

Marking Type Name

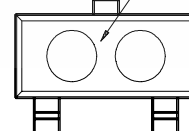

# KRC401 ~ KRC406

## ELECTRICAL CHARACTERISTICS (Ta=25°C)

CHARACTERISTIC		SYMBOL	TEST CONDITION	MIN.	TYP.	MAX.	UNIT
Output Cut-off Current	KRC401~406	$I_{O(OFF)}$	$V_O=50V, V_I=0$	-	-	500	nA
DC Current Gain	KRC401	$G_I$	$V_O=5V, I_O=10mA$	30	55	-	
	KRC402			50	80	-	
	KRC403			70	120	-	
	KRC404			80	200	-	
	KRC405			80	200	-	
	KRC406			80	200	-	
Output Voltage	KRC401~406	$V_{O(ON)}$	$I_O=10mA, I_I=0.5mA$	-	0.1	0.3	V
Input Voltage (ON)	KRC401	$V_{I(ON)}$	$V_O=0.2V, I_O=5mA$	-	1.5	2.0	V
	KRC402			-	1.8	2.4	
	KRC403			-	2.1	3.0	
	KRC404			-	2.8	5.0	
	KRC405			-	0.8	1.1	
	KRC406			-	0.9	1.3	
Input Voltage (OFF)	KRC401~404	$V_{I(OFF)}$	$V_O=5V, I_O=0.1mA$	1.0	1.2	-	V
	KRC405~406			0.5	0.65	-	
Transition Frequency	KRC401~406	$f_T$ *	$V_O=10V, I_O=5mA$	-	200	-	MHz
Input Current	KRC401	$I_I$	$V_I=5V$	-	-	1.8	mA
	KRC402			-	-	0.88	
	KRC403			-	-	0.36	
	KRC404			-	-	0.18	
	KRC405			-	-	3.6	
	KRC406			-	-	1.8	

Note : \*Characteristic of Transistor Only

# KRC401 ~ KRC406

## ELECTRICAL CHARACTERISTICS (Ta=25°C)

CHARACTERISTIC		SYMBOL	TEST CONDITION	MIN.	TYP.	MAX.	UNIT
Switching Time	Rise Time	KRC401	V <sub>O</sub> =5V V <sub>IN</sub> =5V R <sub>L</sub> =1kΩ	-	0.03	-	μS
		KRC402		-	0.05	-	
		KRC403		-	0.12	-	
		KRC404		-	0.22	-	
		KRC405		-	0.01	-	
		KRC406		-	0.03	-	
	Storage Time	KRC401		-	2.0	-	
		KRC402		-	2.0	-	
		KRC403		-	2.0	-	
		KRC404		-	2.0	-	
		KRC405		-	2.0	-	
		KRC406		-	2.0	-	
	Fall Time	KRC401		-	0.12	-	
		KRC402		-	0.36	-	
		KRC403		-	0.35	-	
		KRC404		-	0.6	-	
		KRC405		-	0.1	-	
		KRC406		-	0.19	-	

# KRC401 ~ KRC406

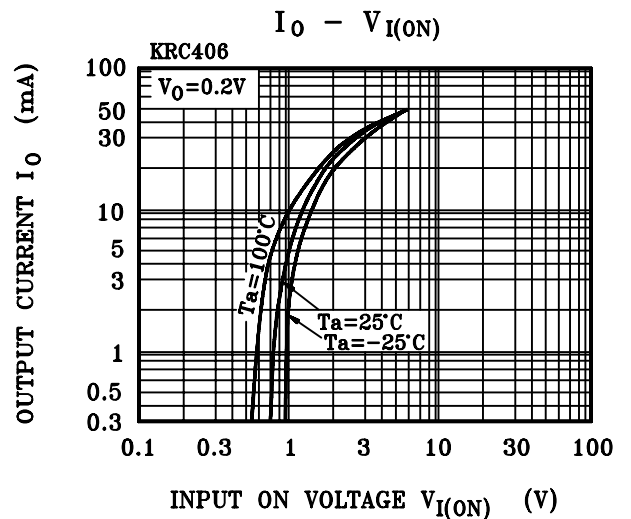
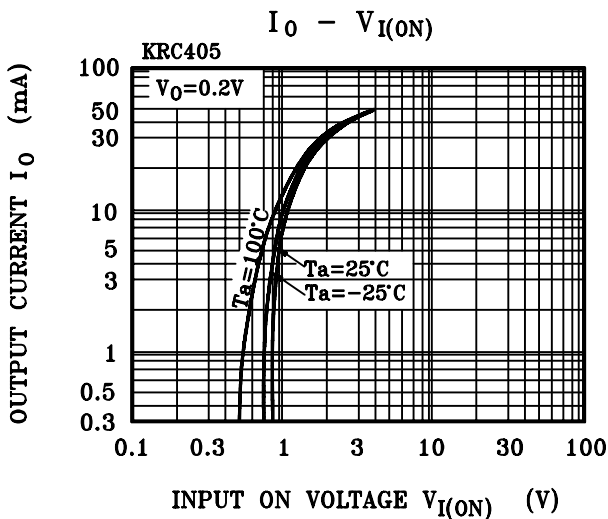
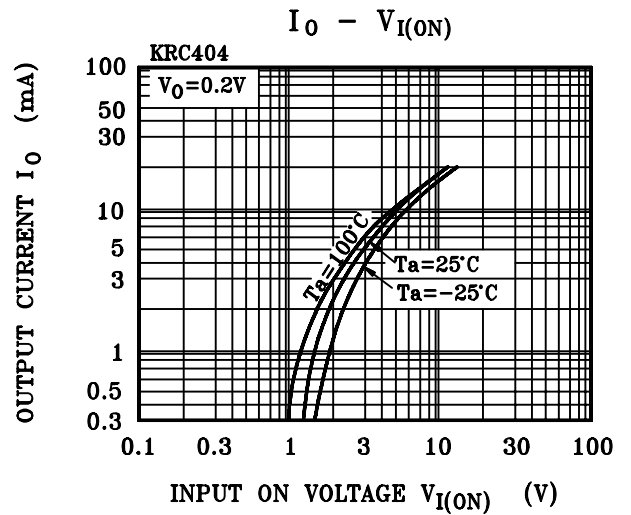
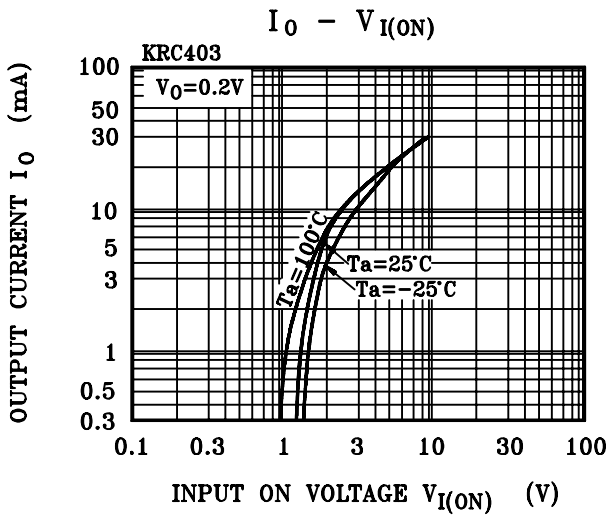
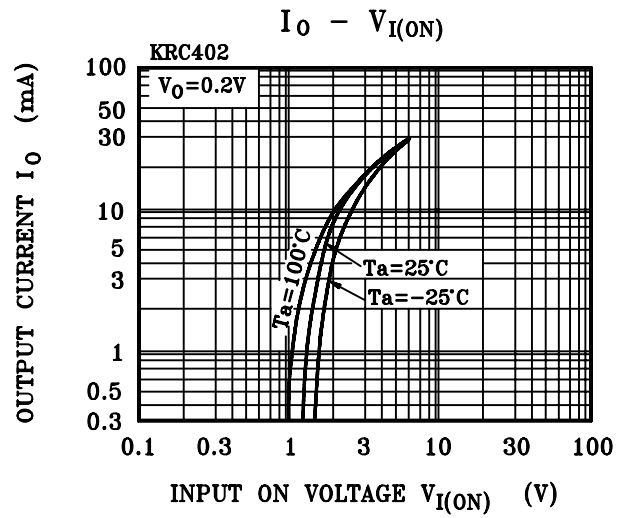
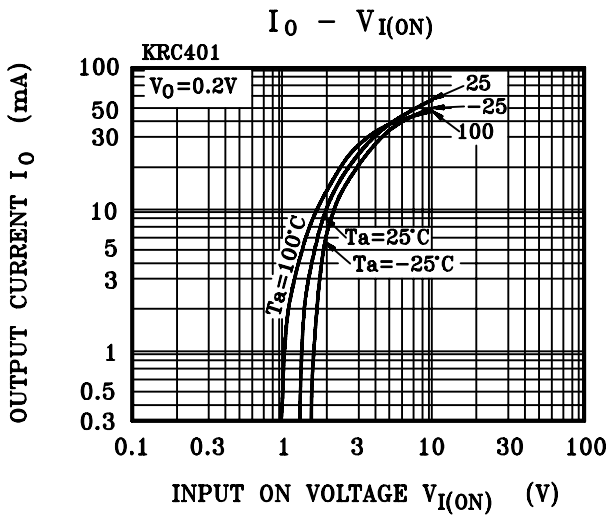

# KRC401 ~ KRC406

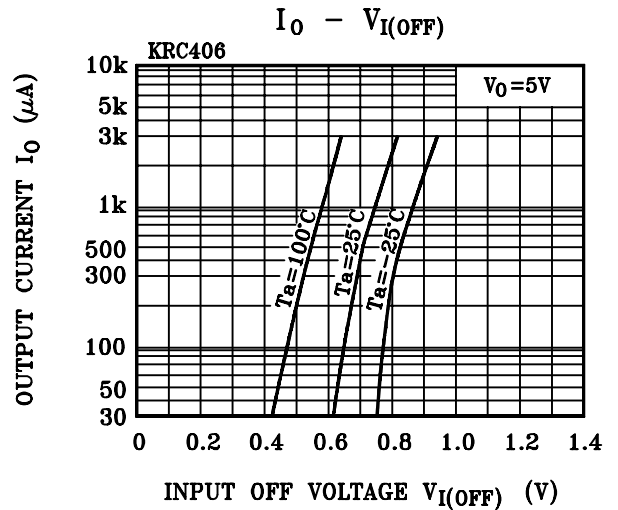
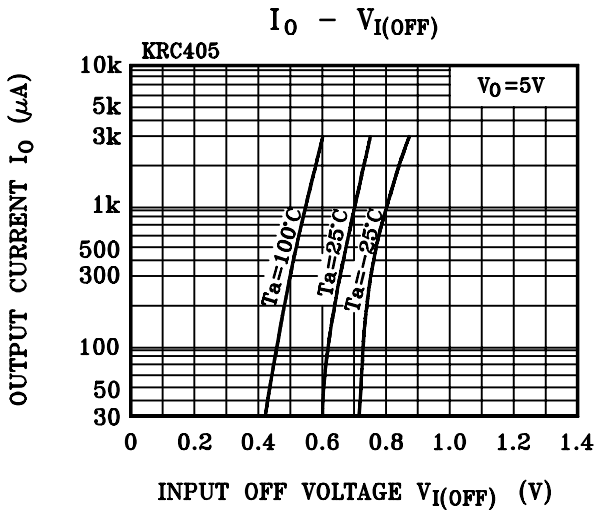
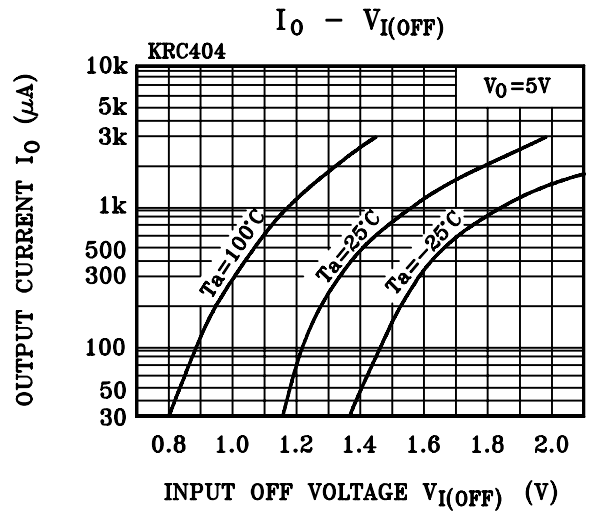
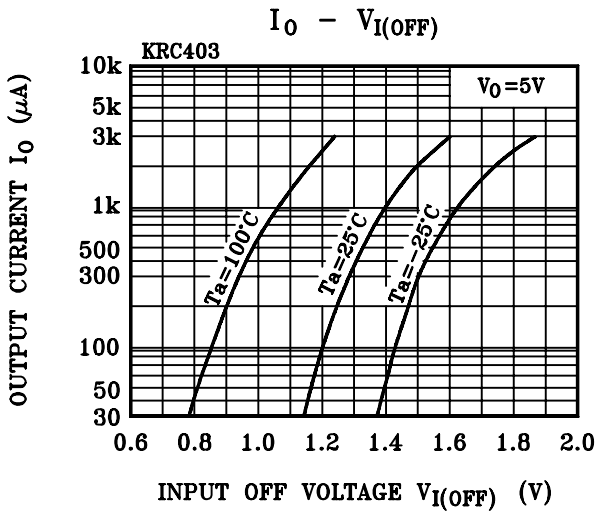
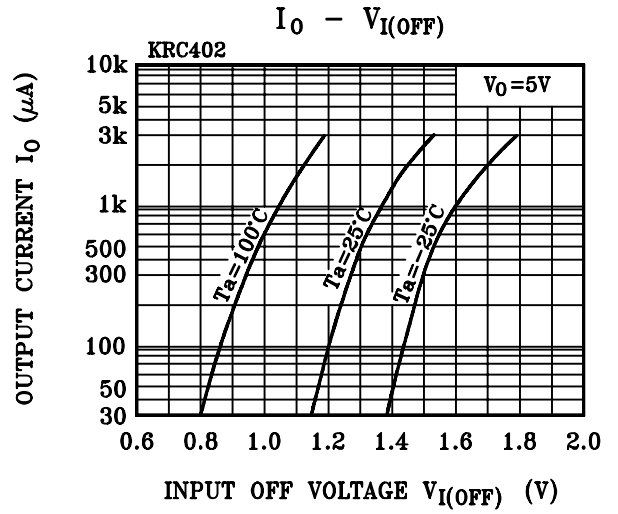
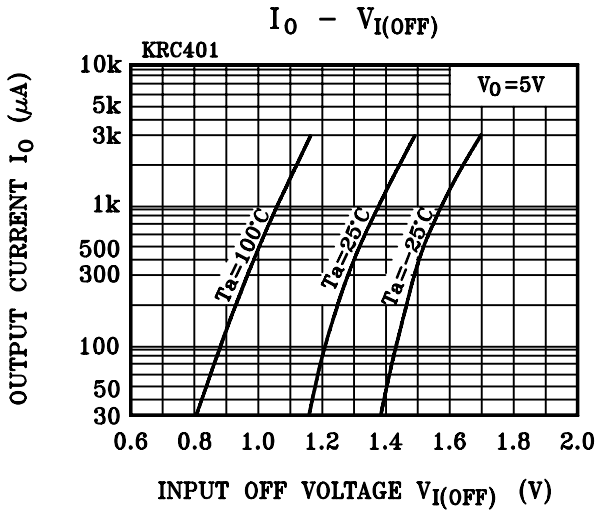

# KRC401 ~ KRC406

